



*State of Palestine (SP)*

**Ministry of Finance – Central Tendering Department  
For the Benefit of Ministry of Education**

**Funded by the  
Joint Financing Partners**

**Tender Documents for the Procurement of Equipment**

**Tender No: MOE/JFA/19.222425/2022/ 171**

**Tender Documents for the Procurement of**

**Tender for the purchase of equipment and tools for several new schools / West Bank**

**under the Joint Financing Arrangement**

2022



# Contents

<b>PART 1 – Bidding Procedures.....</b>	<b>3</b>
Invitation for Bids (IFB).....	4
Section I. Instructions to Bidders (ITB).....	6
Section II. Bidding Data Sheet (BDS).....	27
Section III. Evaluation and Qualification Criteria.....	30
Section IV. Bidding Forms.....	33
<b>PART 2 – Supply Requirements .....</b>	<b>53</b>
Section VI. Schedule of Requirements.....	54
<b>PART 3 - Contract .....</b>	<b>58</b>
Section VII. General Conditions of Contract.....	59
Section VIII. Special Conditions of Contract.....	77
Section IX. Contract Forms .....	82



# PART 1 – Bidding Procedures

---



دعوة لتقديم عطاءات

التاريخ: 17/8/2022

رقم العطاء: MOE/JFA/19.222425/2022/ 171 ( 171/2022 ) .

موضوع العطاء: توريد عدد وأدوات للمختبرات لعدد من المدارس الجديدة / الضفة الغربية.

1. تلقت وزارة التربية والتعليم منحة مالية بقيمة 35 مليون دولار من أربع دول مانحة وهي ألمانيا وفنلندا وإيرلندا والنرويج، فيما يسمى بشركاء التمويل المشترك في إطار تمويل تنفيذ بنود الخطة الاستراتيجية لتطوير التعليم. وعليه تنوي وزارة التربية والتعليم تخصيص جزء من عائدات هذه المنحة توريد عدد وأدوات للمختبرات لعدد من المدارس الجديدة / الضفة الغربية.

بموجب العقد وضمن المناقصة رقم: MOE/JFA/19.222425/2022/ 171 وسوف يتم تطبيق قيمة المنحة المقدمة من شركات التمويل حصريا لتمويل النفقات وصافي ضريبة القيمة المضافة (VAT) .

2. تدعو مديرية اللوازم العامة في وزارة المالية ولحساب وزارة التربية والتعليم الجهات المؤهلة لتقديم العطاءات بالظرف المختم لتوريد المتطلبات لوزارة التربية والتعليم ، ومديريات التربية المذكورة في جدول التوزيع المرفق .

3. يمكن للجهات المعنية بالعطاء الحصول على مزيد من المعلومات من مديرية اللوازم العامة في وزارة المالية وجمع وثائق المناقصة من العنوان المذكور في صفحة معلومات العطاء من 8:00 صباحا وحتى 2:00 بعد الظهر.

4. يوجد مجموعة كاملة من وثائق المناقصة باللغة الانجليزية ويمكن شراؤها من قبل مقدمي العطاءات المعنين برسوم غير مستردة وقيمتها (\$ 100) للنسخة الواحدة.

5. تدفع رسوم كراسة المناقصة لحساب وزارة المالية في بنك فلسطين على حساب رقم (219000/49).

يجب أن يتم تسليم العطاءات الى العنوان الموضح أدناه في موعد أقصاه (يوم الثلاثاء الموافق 2022/9/20) حيث تقبل الطلبات لغاية الساعة (12:00) صباحا من ذلك التاريخ . ويجب أن ترفق جميع العطاءات بكفالة دخول للعطاء والبالغ 3% من قيمة العرض المقدم ، سارية

المفعول لغاية 180 يوم من تاريخ آخر موعد لتقديم عروض الأسعار ، وسيتم رفض العروض المتأخرة عن الموعد المحدد. سيتم فتح العطاءات بحضور ممثلي مقدمي العطاءات الذين يتم اعتماد طلباتهم في العنوان المذكور في صفحة معلومات العطاء في تمام الساعة 12:00. من صباح يوم الثلاثاء الموافق 2022/9/20 .

6. اجور النشر والاعلان على من يرسو عليه العطاء ولمرة واحدة فقط.

7. الأسعار بالدولار وهي غير شاملة لضريبة القيمة المضافة.

مديرية اللوازم العامة

وزارة المالية

مجمع الوزارات الطابق السادس، المصيون

رام الله ( الضفة الغربية )

هاتف: 02-2987112 ، فاكس: 02-2987056

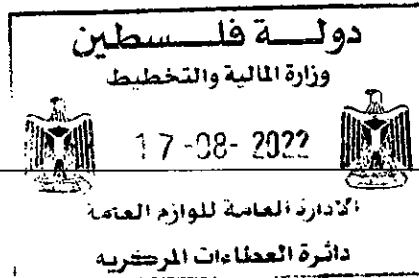

## Invitation for Bids (IFB)

Date: 2022/8/17

Contract Identification No: MOE/JFA/19.222425/2022/ 171

Tender for the purchase of equipment and tools for several new schools / West Bank

The Ministry of Education (MOE) has received a grant of \$35M from the Governments of Germany Finland, Ireland Norway (**Joint Financing Partners, JFPs**) towards financing the implementation of the Education Development Strategic Plan (EDSP). The MOE intends to apply part of the proceeds of this grant to payments under the contract for the **Tender for the purchase of equipment and tools for several new schools / West Bank**

1. under Tender No. **MOE/JFA/19.222425/2022/171**. The grants from JFPs shall be exclusively applied to the financing of expenditures, net of Value Added Tax (VAT).
2. The Directorate of General Supplies (DGS) of the Ministry of Finance (MOF) and for the benefit of the MOE now invites sealed bids from eligible bidders for the **Tender for the purchase of equipment and tools for several new schools / West Bank** for the MOE, the Directorates of Education .in the West Bank.
3. Interested eligible bidders may obtain further information from the Directorate of General Supplies (DGS) at the Ministry of Finance (MOF) of the PA and collect the bidding documents at the address stated in the BDS from 8:00 a.m. to 2:00 p.m.
4. A complete set of bidding documents in *English* may be purchased by interested bidders for payment of a nonrefundable fee of "\$ 100" per copy.

The bidding documents fee shall be paid to the account of the Ministry of Finance under number (219000/49)/ Bank of Palestine until **12:00 am of 2022/9/20**.

5. Bids must be delivered to the address below at or before **12:00 noon of 2022/9/20** All bids must be accompanied by a bid security of 3% of the bid price And is valid for 180 days from the last date for submission of bids. Late bids will be rejected. Bids will be opened in the presence of the bidders' representatives who choose to attend at the address stated in the BDS at **12:00 a.m. on 20/9/2022**.
6. Wages publishing and advertising on who wins the tender and only once . fees are going to be divided according to the number of contracts to be awarded .
7. prices(\$) shall exclude vat.

Directorate General of Supplies.  
Ministry of Finance  
Alquds Building, 6rd Floor,  
Ramallah, West Bank.  
Tel. 02-2987112, Fax. 02-2987056

Head of the Central Tendering Committee

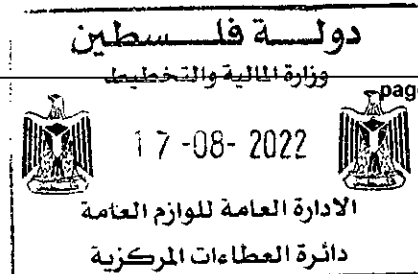

## Section I. Instructions to Bidders

### Table of Contents

<b>A. General</b> .....	8
1. Scope of Bid .....	8
2. Source of Funds .....	8
3. Fraud and Corruption.....	8
4. Eligible Bidders .....	9
5. Eligible Goods and Related Services.....	10
<b>B. Contents of Bidding Documents</b> .....	11
6. Sections of Bidding Documents .....	11
7. Clarification of Bidding Documents .....	11
8. Amendment of Bidding Documents .....	12
<b>C. Preparation of Bids</b> .....	13
9. Cost of Bidding .....	13
10. Language of Bid.....	13
11. Documents Comprising the Bid .....	13
12. Bid Submission Form and Price Schedules .....	13
13. Alternative Bids.....	14
14. Bid Prices and Discounts .....	14
15. Currencies of Bid .....	14
16. Documents Establishing the Eligibility of the Bidder .....	14
17. Documents Establishing the Eligibility of the Goods and Related Services ..	15
18. Documents Establishing the Conformity of the Goods and Related Services	15
19. Documents Establishing the Qualifications of the Bidder.....	15
20. Period of Validity of Bids.....	16
21. Bid Security.....	16
22. Format and Signing of Bid .....	17
<b>D. Submission and Opening of Bids</b> .....	18
23. Submission, Sealing and Marking of Bids.....	18
24. Deadline for Submission of Bids .....	18
25. Late Bids.....	18
26. Withdrawal, Substitution, and Modification of Bids .....	18
27. Bid Opening.....	19
<b>E. Evaluation and Comparison of Bids</b> .....	21
28. Confidentiality .....	21

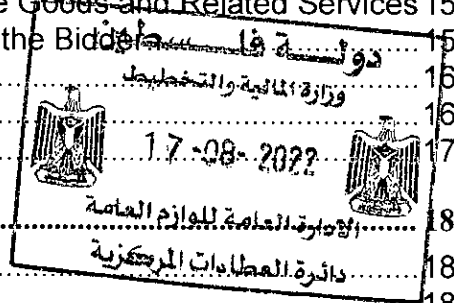

29.	Clarification of Bids .....	21
30.	Responsiveness of Bids .....	21
31.	Nonconformities, Errors, and Omissions .....	22
32.	Preliminary Examination of Bids .....	22
33.	Examination of Terms and Conditions; Technical Evaluation .....	23
34.	Conversion to Single Currency .....	23
35.	Domestic Preference .....	23
36.	Evaluation of Bids .....	23
37.	Comparison of Bids .....	24
38.	Post qualification of the Bidder .....	24
39.	GSD's Right to Accept Any Bid, and to Reject Any or All Bids.....	24
<b>F. Award of Contract.....</b>		<b>25</b>
40.	Award Criteria .....	25
41.	GSD's Right to Vary Quantities at Time of Award .....	25
42.	Notification of Award .....	25
43.	Signing of Contract .....	25
44.	Performance Security .....	25
45.	Reimbursements, Guarantee Or Similar Claimable Payments .....	26



## Section I. Instructions to Bidders

### A. General

- 1. Scope of Bid**
- 1.1 The General Supplies Department (GSD) and for the benefit of the MOE issues these Bidding Documents for the supply of Goods and Related Services incidental thereto as specified in Section VI, Schedule of Requirements. The name and identification number of this Bid are **specified in the Bid Data Sheet (BDS)**. The name, identification, and number of lots are **provided in the BDS**.
- 1.2 Throughout these Bidding Documents:
- (a) The term “in writing” means communicated in written form (e.g. by mail, e-mail, fax) with proof of receipt;
- (b) If the context so requires, “singular” means “plural” and vice versa; and
- (c) “Day” means calendar day.
- 2. Source of Funds**
- 2.1 The Ministry of Education (MOE) has received a grant of \$35M from the Governments of Germany, Finland, Ireland and Norway (**Joint Financing Partners, JFPs**) towards financing the implementation of the Education Development Strategic Plan (EDSP). The MOE intends to apply a portion of the funds to eligible payments under the contract for which these Bidding Documents are issued.
- 3. Fraud and Corruption**
- 3.1 It is a policy to require that (GSD) s as well as bidders, suppliers, and contractors and their subcontractors observe the highest standard of ethics during the procurement and execution of such contracts. In pursuance of this policy, the (GSD):
- (a) defines, for the purposes of this provision, the terms set forth below as follows:
- (i) “corrupt practice” is the offering, giving, receiving or soliciting, directly or indirectly, of anything of value to influence improperly the actions of another party;
- (ii) “fraudulent practice” is any act or omission, including a misrepresentation, that knowingly or recklessly misleads, or attempts to mislead, a party to obtain a financial or other benefit or to avoid an obligation;
- (iii) “collusive practice” is an arrangement between two or





more parties designed to achieve an improper purpose, including to influence improperly the actions of another party;

(iv) “coercive practice” is impairing or harming, or threatening to impair or harm, directly or indirectly, any party or the property of the party to influence improperly the actions of a party;

(v) “obstructive practice” is

(aa) deliberately destroying, falsifying, altering or concealing of evidence material to the investigation or making false statements to investigators in order to materially impede the MOE

investigation into allegations of a corrupt, fraudulent, coercive or collusive practice; and/or threatening, harassing or intimidating any party to prevent it from disclosing its knowledge of matters relevant to the investigation or from pursuing the investigation; or

(b) will cancel a proposal for award if it determines that the bidder recommended for award has, directly or through an agent, engaged in corrupt, fraudulent, collusive, coercive or obstructive practices in competing for the contract in question;

(c) will sanction a firm or individual, including declaring ineligible, either indefinitely or for a stated period of time, to be awarded a contract if it at any time determines that the firm has, directly or through an agent, engaged in corrupt, fraudulent, collusive, coercive or obstructive practices in competing for, or in executing, a contract; and

3.2 Further more, Bidders shall be aware of the provision stated in Sub-Clause 34.1 (a) (iii) of the General Conditions of Contract.

#### 4. Eligible Bidders

4.1 Participation in the bidding procedure is open to all interested Bidders except:

a. For those Bidders ruled out by sanctions issued by the UN Security Council.

b. If the Palestinian Authority prohibits commercial relations with the manufacturing entities or with their Countries.

4.2 A Bidder shall not have a conflict of interest. All bidders found to have conflict of interest shall be disqualified. Bidders may be considered to have a conflict of interest with one or more parties in this bidding process, if they:

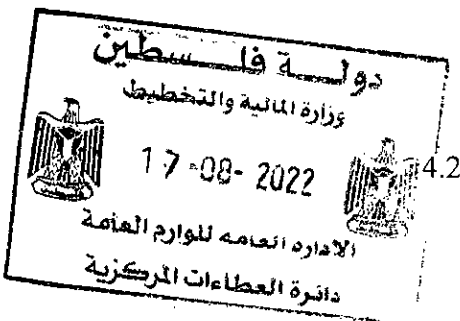

- (a) are or have been associated in the past, with a firm or any of its affiliates which have been engaged by the GSD to provide consulting services for the preparation of the design, specifications, and other documents to be used for the procurement of the goods to be purchased under these Bidding Documents ; or

1. Submit more than one bid in this bidding process.

4.3 Bidders shall provide such evidence of their continued eligibility satisfactory to the GSD, as the GSD shall reasonably request.

**5. Eligible Goods and Related Services**

5.1 All the Goods and Related Services to be supplied under the Contract may have their origin in any country except:

2. As a matter of law or official regulation, the Palestinian Authority prohibits commercial relations with that Country or with the manufacturing entities.

3. by an Act of Compliance with a Decision of the United Nations Security Council taken under Chapter VII of the Charter of the United Nations, the Palestinian Authority prohibits any import of goods from that Country or any payments to persons or entities in that Country.



## B. Contents of Bidding Documents

### 6. Sections of Bidding Documents

6.1 The Bidding Documents consist of Parts 1, 2, and 3, which include all the Sections indicated below, and should be read in conjunction with any Addendum issued in accordance with ITB Clause 8.

#### PART 1 Bidding Procedures

- Section I. Instructions to Bidders (ITB)
- Section II. Bidding Data Sheet (BDS)
- Section III. Evaluation and Qualification Criteria
- Section IV. Bidding Forms
- Section V. Eligible Countries

#### PART 2 Supply Requirements

- Section VI. Schedule of Requirements

#### PART 3 Contract

- Section VII. General Conditions of Contract (GCC)
- Section VIII. Special Conditions of Contract (SCC)
- Section IX. Contract Forms

6.2 The Bidder is expected to examine all instructions, forms, terms, and specifications in the Bidding Documents. Failure to furnish all information or documentation required by the Bidding Documents may result in the rejection of the bid.

### 7. Clarification of Bidding Documents

7.1 A prospective Bidder requiring any clarification of the Bidding Documents shall contact the GSD in writing at the GSD's address **specified in the BDS**. The GSD will respond in writing to any request for clarification, provided that such request is received no later than twenty-one (10) days prior to the deadline for submission of bids. The GSD shall forward copies of its response to all those who have acquired the Bidding Documents directly from it, including a description of the inquiry but without identifying its source.

Should the GSD deem it necessary to amend the Bidding Documents as a result of a clarification, it shall do so following the procedure under ITB Clause 8 and ITB Sub-Clause 24.3.

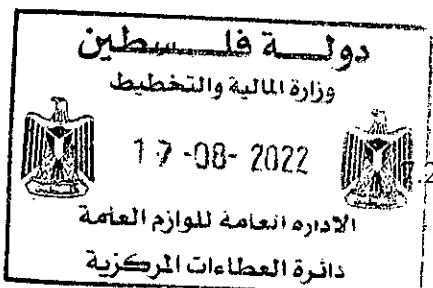

- 8. Amendment of Bidding Documents**
- 8.1 At any time prior to the deadline for submission of bids, the GSD may amend the Bidding Documents by issuing addendum.
- 8.2 Any addendum issued shall be part of the Bidding Documents and shall be communicated in writing to all who have obtained the Bidding Documents directly from the GSD.
- 8.3 To give prospective Bidders reasonable time in which to take an addendum into account in preparing their bids, the GSD may, at its discretion, extend the deadline for the submission of bids, pursuant to ITB Sub-Clause 24.3

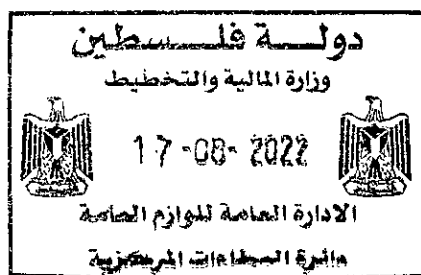

## C. Preparation of Bids

**9. Cost of Bidding** 9.1 The Bidder shall bear all costs associated with the preparation and submission of its bid, and the GSD shall not be responsible or liable for those costs, regardless of the conduct or outcome of the bidding process.

**10. Language of Bid** 10.1 The Bid, as well as all correspondence and documents relating to the bid exchanged by the Bidder and the GSD, shall be written in the language **specified in the BDS**. Supporting documents and printed literature that are part of the Bid may be in another language provided they are accompanied by an accurate translation of the relevant passages into the language **specified in the BDS**, in which case, for purposes of interpretation of the Bid, such translation shall govern.

**11. Documents Comprising the Bid** 11.1 The Bid shall comprise the following:

- Dully signed Declaration of Undertaking furnished in Section IV.
- Bid Submission Form and the applicable Price Schedules, in accordance with ITB Clauses 12, 14, and 15;
- Bid Security in accordance with ITB Clause 21, if required;
- Written confirmation authorizing the signatory of the Bid to commit the Bidder, in accordance with ITB Clause 22;
- Documentary evidence in accordance with ITB Clause 16 establishing the Bidder's eligibility to bid;
- Documentary evidence in accordance with ITB Clause 17, that the Goods and Related Services to be supplied by the Bidder are of eligible origin;
- Documentary evidence in accordance with ITB Clauses 18 and 30, that the Goods and Related Services conform to the Bidding Documents;
- Documentary evidence in accordance with ITB Clause 19 establishing the Bidder's qualifications to perform the contract if its bid is accepted; and
- Any other document **required in the BDS**.



**12. Bid Submission Form and Price** 12.1 The Bidder shall submit the Bid Submission Form using the form furnished in Section IV, Bidding Forms. This form must be completed without any alterations to its format, and no

**Schedules**

substitutes shall be accepted. All blank spaces shall be filled in with the information requested.

12.2 The Bidder shall submit the Price Schedules for Goods and Related Services, according to their origin as appropriate, using the forms furnished in Section IV, Bidding Forms

**13. Alternative Bids**

13.1 Unless otherwise **specified in the BDS**, alternative bids shall not be considered.

**14. Bid Prices and Discounts**

14.1 The prices and discounts quoted by the Bidder in the Bid Submission Form and in the Price Schedules shall conform to the requirements specified below.

14.2 All items must be listed and priced separately in the Price Schedules.

14.3 The price to be quoted in the Bid Submission Form shall be the total price of the bid, excluding any discounts offered.

14.4 The Bidder shall quote any unconditional discounts in the Bid Submission Form or in the Price Schedule Form.

14.5 Unless stated otherwise in the bidding documents, the Contract shall be based on the unit rates and prices in the Bills of Quantities submitted by the bidder.

14.6 All duties, taxes, and other levies payable by the Supplier under the Contract, or for any other cause, as of the date for submission of bids with the exception of Value Added Tax (VAT), shall be included in the rates and prices and the total Bid Price submitted by the bidder. The bid rates and prices shall also include all associated costs to be borne by the Supplier including all overheads and profits.

14.7 Prices quoted by the Bidder shall be fixed during the Bidder's performance of the Contract and not subject to variation on any account. A Bid submitted with an adjustable price quotation shall be treated as non responsive and shall be rejected.



**15. Currencies of Bid**

15.1 The Bidder shall quote in the currency specified in the **BDS**.

**16. Documents Establishing the Eligibility of the Bidder**

16.1 To establish their eligibility in accordance with ITB Clause 4, Bidders shall complete the Bid Submission Form, included in Section IV, Bidding Forms.

- 17. Documents Establishing the Eligibility of the Goods and Related Services**
- 17.1 To establish the eligibility of the Goods and Related Services in accordance with ITB Clause 5, Bidders shall complete the country of origin declarations in the Price Schedule Forms, included in Section IV, Bidding Forms.
- 18. Documents Establishing the Conformity of the Goods and Related Services**
- 18.1 To establish the conformity of the Goods and Related Services to the Bidding Documents, the Bidder shall furnish as part of its Bid the documentary evidence that the Goods conform to the technical specifications and standards specified in Section VI, Schedule of Requirements.
- 18.2 The documentary evidence may be in the form of literature, drawings or data, and shall consist of a detailed item by item description of the essential technical and performance characteristics of the Goods and Related Services, demonstrating substantial responsiveness of the Goods and Related Services to the technical specification, and if applicable, a statement of deviations and exceptions to the provisions of the Schedule of Requirements.
- 18.3 Standards for workmanship, process, material, and equipment, as well as references to brand names or catalogue numbers specified by the MOE in the Schedule of Requirements, are intended to be descriptive only and not restrictive. The Bidder may offer other standards of quality, brand names, and/or catalogue numbers, provided that it demonstrates, to the MOE's satisfaction, that the substitutions ensure substantial equivalence or are superior to those specified in the Schedule of Requirements.
- 19. Documents Establishing the Qualifications of the Bidder**
- 19.1 The documentary evidence of the Bidder's qualifications to perform the contract if its bid is accepted shall establish to the GSD's satisfaction:
- (a) That, if **required in the BDS**, a Bidder that does not manufacture or produce the Goods it offers to supply shall submit the Manufacturer's Authorization using the form included in Section IV, Bidding Forms to demonstrate that it has been duly authorized by the manufacturer or producer of the Goods to supply these Goods in the MOE's Country;
- (b) That, in case of a Bidder not doing business within the MOE's Country, the Bidder is or will be (if awarded the contract) represented by an Agent in the country equipped and able to carry out the Supplier's maintenance, repair and spare parts-stocking obligations prescribed in the Conditions of Contract and/or Technical Specifications; and



- (c) That the Bidder meets each of the qualification criteria specified in Section III, Evaluation and Qualification Criteria.

**20. Period of Validity of Bids**

- 20.1 Bids shall remain valid for the period **specified in the BDS** after the bid submission deadline date prescribed by the GSD. A bid valid for a shorter period shall be rejected by the GSD as non responsive.
- 20.2 In exceptional circumstances, prior to the expiration of the bid validity period, the GSD may request bidders to extend the period of validity of their bids. The request and the responses shall be made in writing. If a Bid Security is requested in accordance with ITB Clause 21, it shall also be extended for a corresponding period. A Bidder may refuse the request without forfeiting its Bid Security. A Bidder granting the request shall not be required or permitted to modify its bid.

**21. Bid Security**

- 21.1 The Bidder shall furnish as part of its bid, a Bid Security as **specified in the BDS**.

- 21.2 The Bid Security shall be in the amount specified in the BDS and denominated in the currency of the Bid and shall:

- (a) Be issued by a reputable institution selected by the bidder and located in any eligible country. If the institution issuing the Bid Security is located outside the Palestinian Territories, it shall have a correspondent financial institution located in the Palestinian Territories to make it enforceable. The Bid Security shall comply with the rules of the Palestinian Monetary Authority.

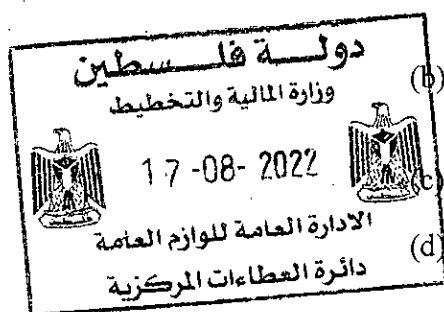

- (b) Be strictly in accordance with the form of Bid Security included in Section IV, Bidding Forms.

- (c) Be payable promptly upon written demand by the GSD;

- (d) Be submitted in its original form; copies will not be accepted;

- 21.3 Any bid not accompanied by a substantially responsive Bid Security shall be rejected by the GSD as non-responsive.

- 21.4 The Bid Security of unsuccessful Bidders shall be returned as promptly as possible upon the successful Bidder's furnishing of the Performance Security pursuant to ITB Clause 44.

- 21.5 The Bid Security may be forfeited or the Bid Securing



Declaration executed:

- (a) If a Bidder withdraws its bid during the period of bid validity specified in the Bidding Documents; or
- (b) If the successful Bidder fails to:
  - (i) Sign the Contract in accordance with ITB Clause 43;
  - (ii) Furnish a Performance Security in accordance with ITB Clause 44.

**22. Format and  
Signing of Bid**

- 22.1 The Bidder shall prepare one original of the documents comprising the bid as described in ITB Clause 11 and clearly mark it "ORIGINAL." In addition, the Bidder shall submit copies of the bid, in the number specified in the **BDS** and clearly mark them "COPY." In the event of any discrepancy between the original and the copies, the original shall prevail.
- 22.2 The original and all copies of the bid shall be typed or written in indelible ink and shall be signed by a person duly authorized to sign on behalf of the Bidder.
- 22.3 Any interlineations, erasures, or overwriting shall be valid only if they are signed or initialed by the person signing the Bid.



## D. Submission and Opening of Bids

### 23. Submission, Sealing and Marking of Bids

23.1 Bidders may submit their bids by mail or by hand (submission by E-mail is not allowed). Bidders submitting bids by mail or by hand, shall enclose the original and each copy of the Bid in separate sealed envelopes, duly marking the envelopes as "ORIGINAL" and "COPY." These envelopes containing the original and the copies shall then be enclosed in one single envelope.

23.2 The inner and outer envelopes shall:

- Bear the name and address of the Bidder;
- Be addressed to the GSD in accordance with ITB Sub-Clause 24.1;
- bear the specific identification of this bidding process indicated in ITB 1.1 and any additional identification marks as **specified in the BDS**; and
- Bear a warning not to open before the time and date for bid opening, in accordance with ITB Sub-Clause 27.1.

23.3 If all envelopes are not sealed and marked as required, the GSD will assume no responsibility for the misplacement or premature opening of the bid.

### 24. Deadline for Submission of Bids

24.1 Bids must be received by the GSD at the address and no later than the date and time **specified in the BDS**.

24.2 If the Bidder choose to submit its bid by mail (submission by E-mail shall not be permitted), the GSD shall not bear any responsibility for any delay in submission.



24.3 The GSD may, at its discretion, extend the deadline for the submission of bids by amending the Bidding Documents in accordance with ITB Clause 8, in which case all rights and obligations of the MOE and Bidders previously subject to the deadline shall thereafter be subject to the deadline as extended.

### 25. Late Bids

25.1 The GSD shall not consider any bid that arrives after the deadline for submission of bids, in accordance with ITB Clause 24. Any bid received by the GSD after the deadline for submission of bids shall be declared late, rejected, and returned unopened to the Bidder.

### 26. Withdrawal, Substitution,

26.1 A Bidder may withdraw, substitute, or modify its Bid after it has been submitted by sending a written notice in accordance with

**and  
Modification of  
Bids**

ITB Clause 23, duly signed by an authorized representative, and shall include a copy of the authorization (the power of attorney) in accordance with ITB Sub-Clause 22.2, (except that no copies of the withdrawal notice are required). The corresponding substitution or modification of the bid must accompany the respective written notice. All notices must be:

- (a) submitted in accordance with ITB Clauses 22 and 23 (except that withdrawal notices do not require copies), and in addition, the respective envelopes shall be clearly marked "WITHDRAWAL," "SUBSTITUTION," or "MODIFICATION;" and
- (b) Received by the GSD prior to the deadline prescribed for submission of bids, in accordance with ITB Clause 24.

26.2 Bids requested to be withdrawn in accordance with ITB Sub-Clause 26.1 shall be returned unopened to the Bidders.

26.3 No bid may be withdrawn, substituted, or modified in the interval between the deadline for submission of bids and the expiration of the period of bid validity specified in the BDS or any extension thereof.

**27. Bid Opening**

27.1 The GSD shall conduct the bid opening in public at the address, date and time **specified in the BDS.**

27.2 First, envelopes marked "WITHDRAWAL" shall be opened and read out and the envelope with the corresponding bid shall not be opened, but returned to the Bidder. If the withdrawal envelope does not contain a copy of the "power of attorney" confirming the signature as a person duly authorized to sign on behalf of the Bidder, the corresponding bid will be opened. No bid withdrawal shall be permitted unless the corresponding withdrawal notice contains a valid authorization to request the withdrawal and is read out at bid opening. Next, envelopes marked "SUBSTITUTION" shall be opened and read out and exchanged with the corresponding Bid being substituted, and the substituted Bid shall not be opened, but returned to the Bidder. No Bid substitution shall be permitted unless the corresponding substitution notice contains a valid authorization to request the substitution and is read out at bid opening. Envelopes marked "MODIFICATION" shall be opened and read out with the corresponding Bid. No Bid modification shall be permitted unless the corresponding modification notice contains a valid authorization to request the modification and is read out at Bid opening. Only envelopes that are opened and read out at Bid

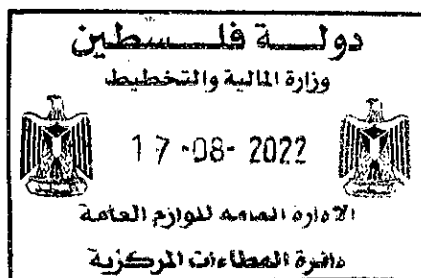

opening shall be considered further.

- 27.3 All other envelopes shall be opened one at a time, reading out: the name of the Bidder and whether there is a modification; the Bid Prices, including any discounts and alternative offers; the presence of a Bid Security and any other details as the GSD may consider appropriate. Only discounts and alternative offers read out at Bid opening shall be considered for evaluation. No Bid shall be rejected at Bid opening except for late bids, in accordance with ITB Sub-Clause 25.1.



## **E. Evaluation and Comparison of Bids**

- 28. Confidentiality**
- 28.1 Information relating to the examination, evaluation, comparison, and post-qualification of bids, and recommendation of contract award, shall not be disclosed to bidders or any other persons not officially concerned with such process until publication of the Contract Award.
- 28.2 Any effort by a Bidder to influence the GSD in the examination, evaluation, comparison, and post qualification of the bids or contract award decisions may result in the rejection of its Bid.
- 28.3 Notwithstanding ITB Sub-Clause 28.2, from the time of bid opening to the time of Contract Award, if any Bidder wishes to contact the GSD on any matter related to the bidding process, it should do so in writing.
- 29. Clarification of Bids**
- 29.1 To assist in the examination, evaluation, comparison and post-qualification of the bids, the GSD may, at its discretion, ask any Bidder for a clarification of its Bid. Any clarification submitted by a Bidder in respect to its Bid and that is not in response to a request by the GSD shall not be considered. The GSD's request for clarification and the response shall be in writing. No change in the prices or substance of the Bid shall be sought, offered, or permitted, except to confirm the correction of arithmetic errors discovered by the GSD in the Evaluation of the bids, in accordance with ITB Clause 31.
- 30. Responsiveness of Bids**
- 30.1 The GSD's determination of a bid's responsiveness is to be based on the contents of the bid itself.
- 30.2 A substantially responsive Bid is one that conforms to all the terms, conditions, and specifications of the Bidding Documents without material deviation, reservation, or omission. A material deviation, reservation, or omission is one that:
- (a) Affects in any substantial way the scope, quality, or performance of the Goods and Related Services specified in the Contract; or
  - (b) Limits in any substantial way, inconsistent with the Bidding Documents, the GSD's rights or the Bidder's obligations under the Contract; or
  - (c) If rectified would unfairly affect the competitive position of other bidders presenting substantially responsive bids.
- 30.3 If a bid is not substantially responsive to the Bidding Documents,

it shall be rejected by the GSD and may not subsequently be made responsive by the Bidder by correction of the material deviation, reservation, or omission.

**31. Nonconformities, Errors, and Omissions**

31.1 Provided that a Bid is substantially responsive, the GSD may waive any non-conformities or omissions in the Bid that do not constitute a material deviation.

31.2 Provided that a bid is substantially responsive, the GSD may request that the Bidder submit the necessary information or documentation, within a reasonable period of time, to rectify nonmaterial nonconformities or omissions in the bid related to documentation requirements. Such omission shall not be related to any aspect of the price of the Bid. Failure of the Bidder to comply with the request may result in the rejection of its Bid.

31.3 Provided that the Bid is substantially responsive, the GSD shall correct arithmetical errors on the following basis:

- (a) If there is a discrepancy between the unit price and the line item total that is obtained by multiplying the unit price by the quantity, the unit price shall prevail and the line item total shall be corrected, unless in the opinion of the GSD there is an obvious misplacement of the decimal point in the unit price, in which case the line item total as quoted shall govern and the unit price shall be corrected;
- (b) If there is an error in a total corresponding to the addition or subtraction of subtotals, the subtotals shall prevail and the total shall be corrected; and
- (c) If there is a discrepancy between words and figures, the amount in words shall prevail, unless the amount expressed in words is related to an arithmetic error, in which case the amount in figures shall prevail subject to (a) and (b) above.

31.4 If the Bidder that awarded the Bid or part of the Bid does not accept the correction of errors, its Bid shall be rejected and its Bid Security shall be forfeited proportionally.

**32. Preliminary Examination of Bids**

32.1 The GSD shall examine the bids to confirm that all documents and technical documentation requested in ITB Clause 11 have been provided, and to determine the completeness of each document submitted.

The GSD shall confirm that the following documents and information have been provided in the Bid. If any of these documents or information is missing, the offer shall be rejected.

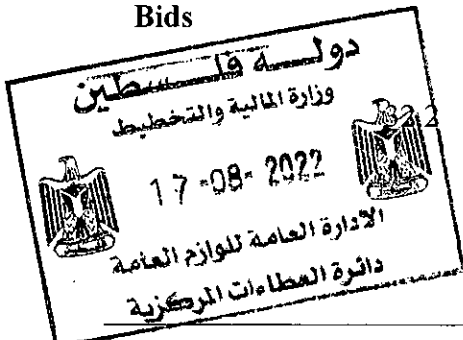

- (a) Bid Submission Form, in accordance with ITB Sub-Clause 12.1;
- (b) Price Schedules, in accordance with ITB Sub-Clause 12.2;
- (c) Bid Security, in accordance with ITB Clause 21.
- (d) The duly signed Declaration of Undertaking attached in Section IV "Bidding Forms"
- 33. Examination of Terms and Conditions; Technical Evaluation**
- 33.1 The GSD shall examine the Bid to confirm that all terms and conditions specified in the GCC and the SCC have been accepted by the Bidder without any material deviation or reservation.
- 33.2 The GSD shall evaluate the technical aspects of the Bid submitted in accordance with ITB Clause 18, to confirm that all requirements specified in Section VI, Schedule of Requirements of the Bidding Documents have been met without any material deviation or reservation.
- 33.3 If, after the examination of the terms and conditions and the technical evaluation, the GSD determines that the Bid is not substantially responsive in accordance with ITB Clause 30, it shall reject the Bid.
- 34. Conversion to Single Currency**
- 34.1 For evaluation and comparison purposes, the GSD shall convert all bid prices expressed in amounts in various currencies into an amount in a single currency **specified in the BDS**, using the selling exchange rates established by the source and on the date **specified in the BDS**.
- 35. Domestic Preference**
- 35.1 Domestic preference shall not be a factor in bid evaluation.
- 36. Evaluation of Bids**
- 36.1 The GSD shall evaluate each bid that has been determined, up to this stage of the evaluation, to be substantially responsive.
- 36.2 To evaluate a Bid, the GSD shall only use all the factors, methodologies and criteria defined in ITB Clause 36. No other criteria or methodology shall be permitted.

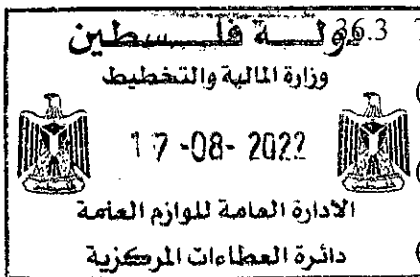

36.3 To evaluate a Bid, the GSD shall consider the following:

- (a) Evaluation will be done for Items, as **specified in the BDS**; and the Bid Price as quoted in accordance with clause 14;
- (b) Price adjustment for correction of arithmetic errors in accordance with ITB Sub-Clause 31.3;
- (c) Price adjustment due to discounts offered in accordance with ITB Sub-Clause 14.4;

- 37. Comparison of Bids**
- 37.1 The GSD shall compare all substantially responsive bids.
- 37.2 Bids will be compared By Group.
- 38. Post qualification of the Bidder**
- 38.1 The GSD shall determine to its satisfaction whether the Bidder that is selected as having submitted the lowest evaluated and substantially responsive bid is qualified to perform the Contract satisfactorily.
- 38.2 The determination shall be based upon an examination of the documentary evidence of the Bidder's qualifications submitted by the Bidder, pursuant to ITB Clause 19.
- 38.3 An affirmative determination shall be a prerequisite for award of the Contract to the Bidder. A negative determination shall result in disqualification of the bid, in which event the GSD shall proceed to the next lowest evaluated bid to make a similar determination of that Bidder's capabilities to perform satisfactorily.
- 39. GSD's Right to Accept Any Bid, and to Reject Any or All Bids**
- 39.1 The GSD reserves the right to accept or reject any bid, and to annul the bidding process and reject all bids at any time prior to contract award, without thereby incurring any liability to Bidders.





## F. Award of Contract

- 40. Award Criteria**
- 40.1 The GSD shall award groups to the Bidder whose offer for that group has been determined to be the lowest evaluated offer and is substantially responsive to the Bidding Documents, provided further that the Bidder is determined to be qualified to perform the Contract satisfactorily.
- 40.2 The Contract of each Bidder will comprise all the groups for which the Bidder has offered the lowest price according to 40.1 above.
- 41. GSD's Right to Vary Quantities at Time of Award**
- 41.1 At the time the Contract is awarded, the GSD reserves the right to increase or decrease the quantity of Goods and Related Services originally specified in Section VI, Schedule of Requirements, provided this does not exceed the percentages **specified in the BDS**, and without any change in the unit prices or other terms and conditions of the bid and the Bidding Documents.
- 42. Notification of Award**
- 42.1 Prior to the expiration of the period of bid validity, the GSD shall notify the successful Bidder, in writing, that its Bid has been accepted.
- 42.2 Until a formal Contract is prepared and executed, the notification of award shall constitute a binding Contract.
- 42.3 Upon the successful Bidder's furnishing of the signed Contract Form and performance security pursuant to ITB Clause 44, the GSD will promptly notify each unsuccessful Bidder and will discharge its bid security, pursuant to ITB Clause 21.4.
- 43. Signing of Contract**
- 43.1 Within fourteen (14) days of receipt of the notification of award from the GSD, the successful Bidder(s) shall come to the GSD offices in Ramallah to sign the Contract Agreement.
- 44. Performance Security**
- 44.1 Within fourteen (14) days of the receipt of notification of award from the GSD, the successful Bidder shall furnish the Performance Security in accordance with the GCC, using for that purpose the Performance Security Form included in Section IX Contract forms. The GSD shall promptly notify the name of the winning Bidder(s) to each unsuccessful Bidder and discharge the Bid Securities of the unsuccessful bidders pursuant to ITB Sub-Clause 21.4.
- 44.2 Failure of the successful Bidder(s) to submit the above-mentioned Performance Security or sign the Contract shall constitute sufficient grounds for the annulment of the award and



forfeiture of the Bid Security. In that event the GSD may award the Contract to the next lowest evaluated Bidder, whose offer is substantially responsive and is determined by the GSD to be qualified to perform the Contract satisfactorily.

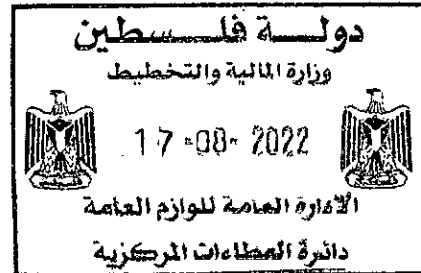

**45. Reimbursements, Guarantee Or Similar Claimable Payments**

4. Any reimbursements, guarantee or similar claimable payments and any insurance payments shall be made to the Palestinian Ministry of Finance's Account Number (219000/49) in the Bank of Palestine, SWIFT Code PALSPS22.



## Section II. Bidding Data Sheet (BDS)

The following specific data for the goods to be procured shall complement, supplement, or amend the provisions in the Instructions to Bidders (ITB). Whenever there is a conflict, the provisions herein shall prevail over those in ITB.

<b>ITB Clause Reference</b>	<b>A. General</b>
<b>ITB 1.1</b>	<p>The name and identification number of the Tender :</p> <p><b>Tender for the purchase of equipment and tools for several new schools / West Bank</b></p> <p><i>[tender number MOE/JFA/19.222425/2022/ 171 ]</i></p> <p>The number, identification and names of the lots comprising this Bid are:  <i>/Tender for the purchase of equipment and tools for several new schools / West Bank/</i></p>
<b>ITB 2.1</b>	The name of the Project is: <i>[JFA]</i>
	<b>B. Contents of Bidding Documents</b>
<b>ITB 7.1</b>	<p>For <b>Clarification of bid purposes</b> only, the Directorate of General Supplies' address is:</p> <p>Attention: Directorate of General Supplies          Ministry of Finance          Alquds Building, 6rd Floor,          Ramallah, West Bank.          Tel. ++97022987112          Fax. ++97022987056</p> <div data-bbox="1038 1332 1450 1608" style="border: 1px solid black; padding: 5px; text-align: center;"> <p>دولة فلسطين          وزارة المالية والتخطيط          17-08-2022          لإدارة العامة للوازم العامة          دائرة العطاءات المركزية</p>   </div>
	<b>C. Preparation of Bids</b>
<b>ITB 10.1</b>	The language of the bid is " <i>English</i> "
<b>ITB 11.1 (h)</b>	<p>The Bidder shall submit the following additional documents in its bid:</p> <ul style="list-style-type: none"> <li>- The original catalogs must be attached.</li> <li>- Brands must certified by the manufacturer.</li> </ul> <p>No additional documents are required.</p>

Section II. Bidding Data Sheet

ITB 13.1	Alternative Bids shall not be considered.
ITB 14.7	The prices quoted by the Bidder shall not be adjustable.
ITB 14.8	Prices quoted for each item shall correspond at least to 100 percent of the quantities specified for this item of a lot.
ITB 15.1	The Bidder <i>is</i> required to quote in US Dollars.
ITB 19.1 (a)	Manufacturer's authorization is required .
ITB 19.1 (b)	After sales service is: <i>required</i>
ITB 20.1	The bid validity period shall be <b>150 days</b> .
ITB 21.1	Bid shall include a Bid Security issued by a bank in the form included in Section IV Bidding Forms and comply with the conditions of ITB 21.
ITB 21.2	<b><u>The amount of the Bid Security shall be 3% of the bidder total bid and valid for 180 days from bid submission date .</u></b>
ITB 22.1	In addition to the original of the bid, the number of copies is: (1)
	<b>D. Submission and Opening of Bids</b>
ITB 23.2 (c)	The inner and outer envelopes shall bear the following additional identification marks: Tender for the purchase of equipment and tools for several new schools / West Bank, <b>MOE/JFA/19.222425/2022/ 171 .J.</b>
ITB 24.1	For bid submission purposes the address is: Directorate of General Supplies Ministry of Finance Alquds Building, 6rd Floor, Ramallah, West Bank Tel. ++97022987112 Fax. ++97022987056 The deadline for the submission of bids is: Date: <i>13 September 2022</i> Time: <i>11:30 a.m</i>
ITB 27.1	The bid opening shall take place at: Directorate of General Supplies Ministry of Finance



ITB 13.1	Alternative Bids shall not be considered.
ITB 14.7	The prices quoted by the Bidder shall not be adjustable.
ITB 14.8	Prices quoted for each item shall correspond at least to 100 percent of the quantities specified for this item of a lot.
ITB 15.1	The Bidder <i>is</i> required to quote in US Dollars.
ITB 19.1 (a)	Manufacturer's authorization is required .
ITB 19.1 (b)	After sales service is: <i>required</i>
ITB 20.1	The bid validity period shall be <b>150 days</b> .
ITB 21.1	Bid shall include a Bid Security issued by a bank in the form included in Section IV Bidding Forms and comply with the conditions of ITB 21.
ITB 21.2	<b><u>The amount of the Bid Security shall be 3% of the bidder total bid and valid for 180 days from bid submission date .</u></b>
ITB 22.1	In addition to the original of the bid, the number of copies is: (1)
	<b>D. Submission and Opening of Bids</b>
ITB 23.2 (c)	The inner and outer envelopes shall bear the following additional identification marks: Tender for the purchase of equipment and tools for several new schools / West Bank, <b>MOE/JFA/19.222425/2022/ 171 .</b>
ITB 24.1	For bid submission purposes the address is: Directorate of General Supplies Ministry of Finance Alquds Building, 6rd Floor, Ramallah, West Bank Tel. ++97022987112 Fax. ++97022987056 The deadline for the submission of bids is: Date: <i>20 September 2022</i> Time: <i>12:00 a.m</i>
ITB 27.1	The bid opening shall take place at: Directorate of General Supplies Ministry of Finance



	Alquds Building, 6rd Floor, Ramallah, West Bank Tel. ++97022987112 Fax. ++97022987056 Date: 20 September 2022 Time: 12:00 a.m
	<b>E. Evaluation and Comparison of Bids</b>
<b>ITB 34.1</b>	Bid prices expressed in different currencies shall be converted in: <b>Not Applicable</b>
<b>ITB 36.3(a)</b>	Bids will be evaluated by Group.  Bids will be evaluated and awarded per group and the Contract will comprise all the group (s) awarded to the successful Bidder (lowest price for these items).
<b>ITB 36.3(d)</b>	The adjustments shall be determined using the following criteria, from amongst those set out in Section III, Evaluation and Qualification Criteria:  (a) Deviation in Delivery schedule: <i>No</i> .  (b) Deviation in payment schedule: <i>No</i> .
<b>ITB 36.6</b>	Bidders <i>shall</i> be allowed to quote separate prices for groups.
	<b>F. Award of Contract</b>
<b>ITB 41.1</b>	The maximum percentage by which quantities may be increased is: 25%  The maximum percentage by which quantities may be decreased is: 25%



## Section III. Evaluation and Qualification Criteria

### Contents

#### 1. Post-qualification Requirements (ITB 38.2)

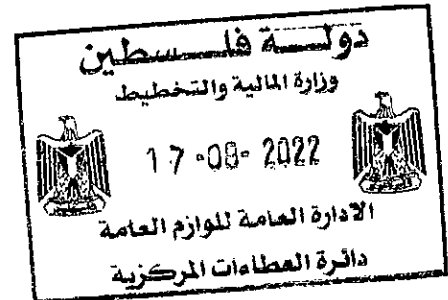

**1. Post-qualification Requirements (ITB 38.2)**

The GSD will carry out the post-qualification of the Bidder in accordance with ITB Clause 38, using only the requirements specified. For any Bidder to pass the post-qualification, he shall satisfy all the requirements listed below. If any of the listed requirements is not fulfilled the Bidder will be considered as unsuccessful and he will not be financially evaluated:

**a. Local Bidders:**

- The Bidder shall be in business related to the scope of the Bid for at least one year.
- The Bidder shall be legally registered with the Ministry of National Economy of the Palestinian Authority.
- The Bidder shall be registered for the purpose of taxation with the Ministry of Finance of the Palestinian Authority.
- The Bidder shall submit an approved financial report approved by an authorized legal auditor for the last three years evidencing the generation of profit. If the business life is less than three years then the report shall cover the business life.

**b. International Bidders:**

5. The Bidder shall have a legal address in the Palestinian Territories.
6. The Bidder shall be registered for purposes of taxation with the Ministry of Finance of the Palestinian Authority.
7. The Bidder shall have a legally registered Local Agent (The local agent shall not participate in the bid independently. If so happen both the International Bidder as well as the Local Agent will be disqualified).
8. Financial Capability

The Bidder shall furnish documentary evidence that it meets the following financial requirement(s):

- The Bidder shall submit an approved financial report for the last three years evidencing the generation of profit.
- Annual average turnover for the last five years not less than TWICE the value of his bid.

**9. Experience and Technical Capacity**

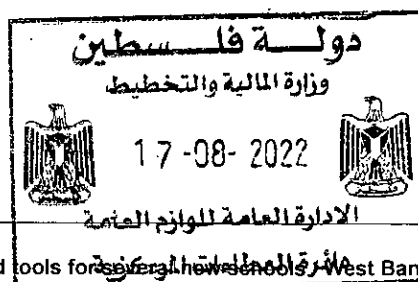



### Section III. Evaluation and Qualification Criteria

The Bidder shall furnish documentary evidence to demonstrate that it meets the following experience requirement(s):

- The Bidder shall be in the business for at least the last (5) continuous years.
- The Bidder shall have implemented at least (3) similar contracts over the past (5) years.

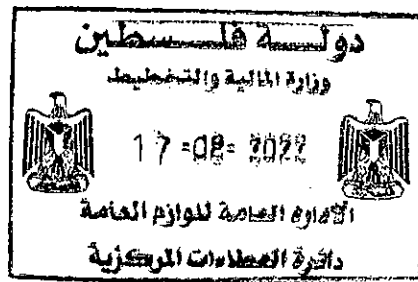

## Section IV. Bidding Forms

### Table of Forms

Declaration of Undertaking.....	34
Bid Submission Form.....	37
Bidder Information Form.....	39
Joint Venture Partner Information Form.....	40
Price Schedule Form.....	41
Manufacturer's Authorization.....	52



## Declaration of Undertaking

### (i) Declaration of Undertaking

Reference name of the Application/Offer/Contract:

("Contract")<sup>1</sup>

To:

("Project Executing Agency")

1. We recognise and accept that JFA only finances projects of the Project Executing Agency ("PEA")<sup>2</sup> subject to its own conditions which are set out in the Funding Agreement it has entered into with the PEA. As a matter of consequence, no legal relationship exists between JFA and our company, our Joint Venture or our Subcontractors under the Contract. The PEA retains exclusive responsibility for the preparation and implementation of the Tender Process and the performance of the Contract.
2. We hereby certify that neither we nor any of our board members or legal representatives nor any other member of our Joint Venture including Subcontractors under the Contract are in any of the following situations:
  - 2.1) being bankrupt, wound up or ceasing our activities, having our activities administered by courts, having entered into receivership, reorganisation or being in any analogous situation;
  - 2.2) convicted by a final judgement or a final administrative decision or subject to financial sanctions by the United Nations, the European Union or Germany for involvement in a criminal organisation, money laundering, terrorist-related offences, child labour or trafficking in human beings; this criterion of exclusion is also applicable to legal Persons, whose majority of shares are held or factually controlled by natural or legal Persons which themselves are subject to such convictions or sanctions;
  - 2.3) having been convicted by a final court decision or a final administrative decision by a court, the European Union, national authorities in the Partner Country or in Germany for Sanctionable Practice in connection with a Tender Process or the performance of a Contract or for an irregularity affecting the EU's financial interests (*in the event of such a conviction, the Applicant or Bidder shall attach to this Declaration of Undertaking supporting information showing that this conviction is not relevant in the context of this Contract and that adequate compliance measures have been taken in reaction*);
  - 2.4) having been subject within the past five years to a Contract termination fully settled against us for significant or persistent failure to comply with our contractual obligations during such Contract performance, unless this termination was challenged and dispute resolution is still pending or has not confirmed a full settlement against us;
  - 2.5) not having fulfilled applicable fiscal obligations regarding payments of taxes either in the country where we are constituted or the PEA's country;

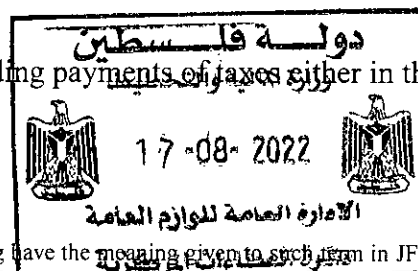

<sup>1</sup> Capitalised terms used, but not otherwise defined in this Declaration of Undertaking have the meaning given to such term in JFA's "Guidelines for the Procurement of Consulting Services, Works, Plant, Goods and Non-Consulting Services in Financial Cooperation with Partner Countries".

<sup>2</sup> The PEA means the purchaser, the employer, the client, as the case may be, for the procurement of Consulting Services, Works, Plant, Goods or Non-Consulting Services.

- 2.6) being subject to an exclusion decision of the World Bank or any other multilateral development bank and being listed on the website <http://www.worldbank.org/debarr> or respectively on the relevant list of any other multilateral development bank (*in the event of such exclusion, the Applicant or Bidder shall attach to this Declaration of Undertaking supporting information showing that this exclusion is not relevant in the context of this Contract and that adequate compliance measures have been taken in reaction*); or
- 2.7) being guilty of misrepresentation in supplying the information required as a condition of participation in the Tender.
3. We hereby certify that neither we, nor any of the members of our Joint Venture or any of our Subcontractors under the Contract are in any of the following situations of conflict of interest:
- 3.1) being an affiliate controlled by the PEA or a shareholder controlling the PEA, unless the stemming conflict of interest has been brought to the attention of JFA and resolved to its satisfaction;
- 3.2) having a business or family relationship with a PEA's staff involved in the Tender Process or the supervision of the resulting Contract, unless the stemming conflict of interest has been brought to the attention of JFA and resolved to its satisfaction;
- 3.3) being controlled by or controlling another Applicant or Bidder, or being under common control with another Applicant or Bidder, or receiving from or granting subsidies directly or indirectly to another Applicant or Bidder, having the same legal representative as another Applicant or Bidder, maintaining direct or indirect contacts with another Applicant or Bidder which allows us to have or give access to information contained in the respective Applications or Offers, influencing them or influencing decisions of the PEA;
- 3.4) being engaged in a Consulting Services activity, which, by its nature, may be in conflict with the assignments that we would carry out for the PEA;
- 3.5) in the case of procurement of Works, Plant or Goods:
- having prepared or having been associated with a Person who prepared specifications, drawings, calculations and other documentation to be used in the Tender Process of this Contract;
  - having been recruited (or being proposed to be recruited) ourselves or any of our affiliates, to carry out works supervision or inspection for this Contract;
4. If we are a state-owned entity, and compete in a Tender Process, we certify that we have legal and financial autonomy and that we operate under commercial laws and regulations.
5. We undertake to bring to the attention of the PEA, which will inform JFA, any change in situation with regard to points 2 to 4 here above.
6. In the context of the Tender Process and performance of the corresponding Contract:
- 6.1) neither we nor any of the members of our Joint Venture nor any of our Subcontractors under the Contract have engaged or will engage in any Sanctionable Practice during the Tender Process and in the case of being awarded a Contract will engage in any Sanctionable Practice during the performance of the Contract;

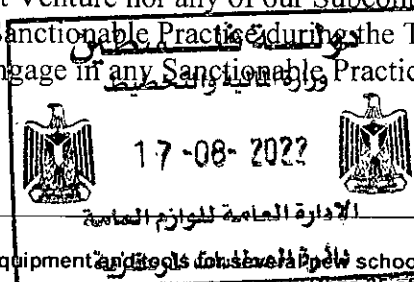

## Section IV. Bidding Forms

- 6.2) neither we nor any of the members of our Joint Venture or any of our Subcontractors under the Contract shall acquire or supply any equipment nor operate in any sectors under an embargo of the United Nations, the European Union or Germany; and
- 6.3) we commit ourselves to complying with and ensuring that our Subcontractors and major suppliers under the Contract comply with international environmental and labour standards, consistent with laws and regulations applicable in the country of implementation of the Contract and the fundamental conventions of the International Labour Organisation<sup>3</sup> (ILO) and international environmental treaties. Moreover, we shall implement environmental and social risks mitigation measures when specified in the relevant environmental and social management plans or other similar documents provided by the PEA and, in any case, implement measures to prevent sexual exploitation and abuse and gender based violence.
7. In the case of being awarded a Contract, we, as well as all members of our Joint Venture partners and Subcontractors under the Contract will, (i) upon request, provide information relating to the Tender Process and the performance of the Contract and (ii) permit the PEA and JFA or an agent appointed by either of them, and in the case of financing by the European Union also to European institutions having competence under European Union law, to inspect the respective accounts, records and documents, to permit on-the-spot checks and to ensure access to sites and the respective project.
8. In the case of being awarded a Contract, we, as well as all our Joint Venture partners and Subcontractors under the Contract undertake to preserve above mentioned records and documents in accordance with applicable law, but in any case for at least six years from the date of fulfillment or termination of the Contract. Our financial transactions and financial statements shall be subject to auditing procedures in accordance with applicable law. Furthermore, we accept that our data (including personal data) generated in connection with the preparation and implementation of the Tender Process and the performance of the Contract are stored and processed according to the applicable law by the PEA and JFA.

Name: \_\_\_\_\_ In the capacity of: \_\_\_\_\_

Duly empowered to sign in the name and on behalf of<sup>d</sup>: \_\_\_\_\_

Signature: \_\_\_\_\_

Dated: \_\_\_\_\_



هناك خطأ في التوقيع

A. <sup>3</sup> In case ILO conventions have not been fully ratified or implemented in the Employer's country the Applicant/Bidder/Contractor shall, to the satisfaction of the Employer and JFA, propose and implement appropriate measures in the spirit of the said ILO conventions with respect to a) workers grievances on working conditions and terms of employment, b) child labour, c) forced labour, d) worker's organisations and e) non-discrimination.

<sup>4</sup> In the case of a JV, insert the name of the JV. The person who will sign the application, bid or proposal on behalf of the Applicant/Bidder shall attach a power of attorney from the Applicant/Bidder.

## Bid Submission Form

*[The Bidder shall fill in this Form in accordance with the instructions indicated No alterations to its format shall be permitted and no substitutions shall be accepted.]*

Date: *[insert date (as day, month and year) of Bid Submission]*

ICB No.: *[insert number of bidding process]*

Invitation for Bid No.: *[insert No of IFB]*

Alternative No.: *[insert identification No if this is a Bid for an alternative]*

To: *[insert complete name of GSD]*

We, the undersigned, declare that:

(a) We have examined and have no reservations to the Bidding Documents, including Addenda No.: \_\_\_\_\_ *[insert the number and issuing date of each Addenda];*

(b) We offer to supply in conformity with the Bidding Documents and in accordance with the Delivery Schedules specified in the Schedule of Requirements the following Goods and Related Services \_\_\_\_\_ *[insert a brief description of the Goods and Related Services];*

(c) The total price of our Bid, excluding any discounts offered in item (d) below, is: \_\_\_\_\_ *[insert the total bid price in words and figures, indicating the various amounts and the respective currencies];*

(d) The discounts offered and the methodology for their application are \_\_\_\_\_

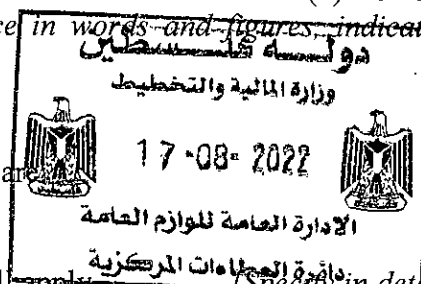

**Discounts.** If our bid is accepted, the following discounts shall apply. \_\_\_\_\_ *[Specify in detail each discount offered and the specific item of the Schedule of Requirements to which it applies.]*

(e) Our bid shall be valid for the period of time specified in ITB Sub-Clause 20.1, from the date fixed for the bid submission deadline in accordance with ITB Sub-Clause 24.1, and it shall remain binding upon us and may be accepted at any time before the expiration of that period;

(f) If our bid is accepted, we commit to obtain a performance security in accordance with ITB Clause 44 and GCC Clause 17 for the due performance of the Contract;

(g) We, including any subcontractors or suppliers for any part of the contract, have nationality from eligible countries \_\_\_\_\_ *[insert the nationality of the Bidder, including that of all parties that comprise the Bidder, if the Bidder is a JV, and the nationality each subcontractor and supplier]*

- (h) We have no conflict of interest in accordance with ITB Sub-Clause 4.2;
- (i) Our firm, its affiliates or subsidiaries—including any subcontractors or suppliers for any part of the contract—has not been declared ineligible by the UN Security Council, under the GSD's country laws or official regulations, in accordance with ITB Sub-Clause 4.1;

10. We understand that this bid, together with your written acceptance thereof included in your notification of award, shall constitute a binding contract between us, until a formal contract is prepared and executed.

- (l) We understand that you are not bound to accept the lowest evaluated bid or any other bid that you may receive.

Signed: \_\_\_\_\_ [insert signature of person whose name and capacity are shown]  
In the capacity of \_\_\_\_\_ [insert legal capacity of person signing the Bid Submission Form]

Name: \_\_\_\_\_ [insert complete name of person signing the Bid Submission Form]

Duly authorized to sign the bid for and on behalf of: \_\_\_\_\_ [insert complete name of Bidder]

Dated on \_\_\_\_\_ day of \_\_\_\_\_, \_\_\_\_\_ [insert date of signing]

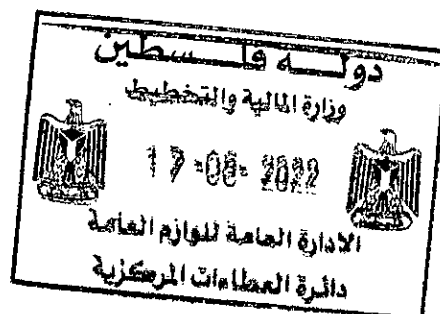

## Bidder Information Form

[The Bidder shall fill in this Form in accordance with the instructions indicated below. No alterations to its format shall be permitted and no substitutions shall be accepted.]

Date: [insert date (as day, month and year) of Bid Submission]

NCB No.: [insert number of bidding process]

Page \_\_\_\_\_ of \_\_\_\_\_ pages

1. Bidder's Legal Name [insert Bidder's legal name]
2. In case of JV, legal name of each party: [insert legal name of each party in JV]
3. Bidder's actual or intended Country of Registration: [insert actual or intended Country of Registration]
4. Bidder's Year of Registration: [insert Bidder's year of registration]
5. Bidder's Legal Address in Country of Registration: [insert Bidder's legal address in country of registration]
<p>11. Bidder's Authorized Representative Information</p> <p>Name: [insert Authorized Representative's name]</p> <p>Address: [insert Authorized Representative's Address]</p> <p>Telephone/Fax numbers: [insert Authorized Representative's telephone/fax numbers]</p> <p>Email Address: [insert Authorized Representative's email address]</p>
<p>12. Attacheded are copies of original documents of: [check the box(es) of the attached original documents]</p> <p><input type="checkbox"/> Articles of Incorporation or Registration of firm named in 1, above, in accordance with ITB Sub-Clauses 4.1 and 4.2.</p> <p><input type="checkbox"/> In case of JV, letter of intent to form JV or JV agreement, in accordance with ITB Sub-Clause 4.1.</p> <p><input type="checkbox"/> In case of government owned entity from the GSD's country, documents establishing legal and financial autonomy and compliance with commercial law.</p>

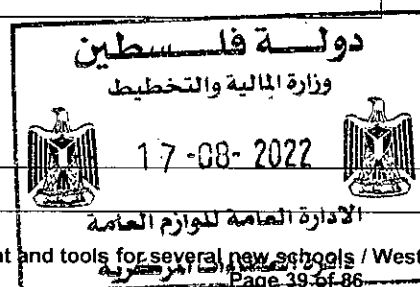



## Joint Venture Partner Information Form

[The Bidder shall fill in this Form in accordance with the instructions indicated below].

Date: [insert date (as day, month and year) of Bid Submission]

NCB No.: [insert number of bidding process]



Page \_\_\_\_\_ of \_\_\_\_\_ pages

1. Bidder's Legal Name: [insert Bidder's legal name]
2. JV's Party legal name: [insert JV's Party legal name]
3. JV's Party Country of Registration: [insert JV's Party country of registration]
4. JV's Party Year of Registration: [insert JV's Party year of registration]
5. JV's Party Legal Address in Country of Registration: [insert JV's Party legal address in country of registration]
<p>13. JV's Party Authorized Representative Information</p> <p>Name: [insert name of JV's Party authorized representative]</p> <p>Address: [insert address of JV's Party authorized representative]</p> <p>Telephone/Fax numbers: [insert telephone/fax numbers of JV's Party authorized representative]</p> <p>Email Address: [insert email address of JV's Party authorized representative]</p>
<p>14. Attached are copies of original documents of: [check the box(es) of the attached original documents]</p> <p><input type="checkbox"/> Articles of Incorporation or Registration of firm named in 2, above, in accordance with ITB Sub-Clauses 4.1 and 4.2.</p> <p><input type="checkbox"/> In case of government owned entity from the GSD's country, documents establishing legal and financial autonomy and compliance with commercial law.</p>





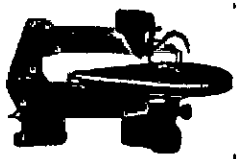

## Price Schedule Form

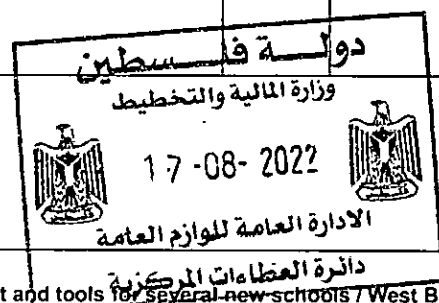
Name of Bidder \_\_\_\_\_ Tender No MOE/JFA/19.222425/2022/171



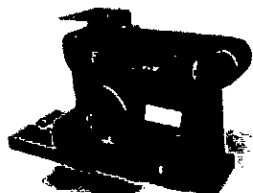

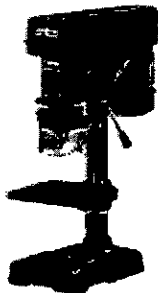
#	Specification	Illustration	5 school	price Unit \$	Total \$
<b>Group - 1 Electrical Tools</b>					
1	<b>Hammer Drill</b>	<ul style="list-style-type: none"> <li>• 1/2" three-jaw chuck for rugged hammer drilling applications</li> <li>• 500 watt at least</li> <li>• Dual-Mode Selector (hammer drill, rotation-only) mode</li> <li>• Variable-Speed Trigger with Reversing</li> <li>• 360° auxiliary handle with built-in quick-release depth gauge</li> </ul>	15		
2	<b>Angle Grinder</b>	<ul style="list-style-type: none"> <li>• 500 watt at least</li> <li>• Wheel Diameter 4-1/2"</li> <li>• Two-Position Auxiliary Handle</li> <li>• Lock-On Slide Switch — For extended-use applications</li> </ul>	10		
3	<b>Jig Saw</b> منشار كهربائي جكسو	<ul style="list-style-type: none"> <li>• 500 watt at least</li> <li>• Electronic speed control</li> </ul>	20		
4	<b>SCROLL SAW</b>	 <p>Power: 80 watt at least Speeds: 400-1800 rpm Throat: 16" Cut Thickness: Up to 2" Table: 298mm diameter, 0-45 degree</p>	5		
5	<b>Drill/Driver</b> مفك بطارية	<p>Battery voltage 12.0 V at least Chuck clamping range 1 - 10 mm Torque settings 4 at least Ratcheting Single-Sleeve 1/2" Chuck — For one-handed bit changes</p>	30		
6	<b>Circular Saw</b> منشار كهربائي دائري	<ul style="list-style-type: none"> <li>• 1200 watt at least</li> <li>• Blade diameter(7-1/4")</li> <li>• Large aluminum wrap-around base</li> <li>• No load speed (rpm) 4200 and more</li> </ul>	10		
7	<b>Combination Mitre/Table Saw</b>	 <p>1200 watt at least Cutting capacity, 0°: 95 × 151 mm Cutting capacity, 45° mitre: 95 × 90 mm Mitre setting: 48 ° L / 48 ° R Incline setting: 47 ° L No-load speed: 4.300 rpm Saw blade diameter: 10"</p>	5		



Section IV. Bidding Forms



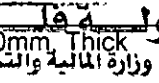

8	<b>Router</b> 	<ul style="list-style-type: none"> <li>• 1400 watt at lest</li> <li>• Collet : 12mm</li> <li>• Plunge capacity 0-60</li> <li>• Base dia 160mm</li> </ul>	5		
9	<b>BELT SANDER</b> 	<ul style="list-style-type: none"> <li>• Two-in-one sanding machine includes both a 4-by-36 inch belt and a 6-by-6 inch disc</li> <li>• Belt tilts anywhere from 0 to 90 degrees</li> <li>• Sturdy cast iron base prevents any heavy vibrations</li> <li>• 4.3 Amp motor provides up to 3600 RPM</li> </ul>	5		
10	<b>Finishing Sander</b> 	<ul style="list-style-type: none"> <li>• 150 watt at lest</li> <li>• Pad size 93 x 185mm at lest</li> </ul>	10		
11	<b>Drill Press</b> 	<ul style="list-style-type: none"> <li>• 350 watt at lest</li> <li>• Drill Capacity 13 mm</li> <li>• Tapping Capacity 5/8" 16 mm</li> <li>• 5 Speeds from 545 - 2530 RPM</li> <li>• Safety features include electrical cut-out on belt guard, combined NVR/stop start switch &amp; clear perspex chuck guard.</li> <li>• Also has dry type tilting work table 165 x 162mm, depth gauge, user reference chart &amp; fitted BS plug.</li> <li>• Dimensions – chuck to column 105mm (horizontal) &amp; chuck to table 168mm (vertical)</li> <li>• Overall height 515mm</li> </ul>	5		
12	<b>Benchtop Abrasive Cutoff Saw</b> 	<ul style="list-style-type: none"> <li>• 1200 watt at lest</li> <li>• Wheel Diameter 14"</li> <li>• Superior Motor Insulation — Extra motor overload protection during tough applications</li> <li>• Locking Vise with Quick-Release — Holds odd-shaped material stable for fast and efficient cutting</li> <li>• Adjustable Fence — Adjusts for bevel cuts ranging from 0-45°</li> <li>• Trigger with Lock-On — For extended-use applications</li> </ul>	5		
13	<b>Meuleuse double</b> 	<ul style="list-style-type: none"> <li>• Rated input power: 350W at least.</li> <li>• No Load Speed: 0-2000 rpm/min at least.</li> <li>• Disc Diameter: 8"</li> </ul>	5		





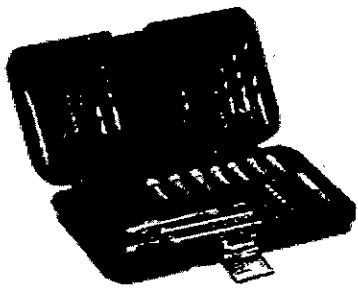
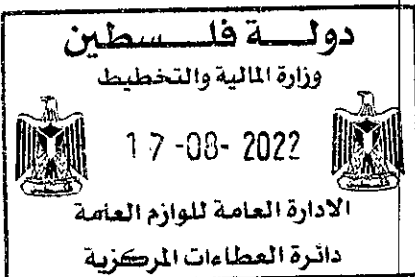

14	<b>13 "Mini Wood Lathe (Brand Name)</b> Sorry! Image unavailable. 	Electronic Variable Speed Distance between centres 325mm Turning Capacity 200mm Motor 0.20hp No. of speeds Variable 890-3190rpm Tailstock Taper 1MT Thread size 3/4" UNF, 16TPI Dims (LWH) 732x222x300mm	5		
15	We're working on it. <b>Electric Welding (Brand Name)</b> 	Mains supply, V/Hz 230/1 50/60 Fuse, slow, A 16 Mains cable, Ø mm2 3 x 2.5 Max output at 25% duty cycle, A 150/26 (MMA) Max output at 60% duty cycle, A 100/24 (MMA) Max output at 100% duty cycle, A 90/23.6 (MMA) Setting range, A 8-150 Open circuit voltage, V 58-72 Power factor at max. current 0.99	5		
<b>Total of Group 1</b>					
<b>Group - 2 Hand Tools</b>					
1	<b>Pliers Set (7 Pieces)</b>	Combination pliers 7" Diagonal Cutting Pliers 6" Long Nose Pliers 6" Wire Stripping Pliers 6" Water Pump Pliers 10" Tower Pincer Curved Jaw Locking Pliers 7"	30		
2	<b>Caustic welding tin</b>	40 Watt at lest Stand Holder solder sucker 	30		
3	<b>Soldering Gun (Brand Name)</b>	 <ul style="list-style-type: none"> <li>• 220V/50Hz power supply, quick heat.</li> <li>• Heavy-duty soldering kit, including 2 spare tips.</li> <li>• Changeable power rating 20/130W.</li> <li>• Tips ranch flux brush, soldering tool.</li> </ul>	5		
4	<b>Adjustable Helping Hand With Magnifying Glass</b>	<ul style="list-style-type: none"> <li>• Wide 4X at least magnification lens that magnifies and enlarges the tiniest micro objects.</li> <li>• Heavy-duty base for stability.</li> </ul> 	35		
5	<b>Utility Knife</b>	168 mm, Blade (W 18mm, L 100mm, Thick 0.5mm). 	30		



Section IV. Bidding Forms



6	Meters measure the	3-meter 3/4" 	30		
7	Hammers set	Claw Hammer 330-350 mm 200 Gram Hammer 330-350 mm Rubber Hammer 200 Gram	30		
8	Screwdrivers set (9 Pieces)	Phillips (PH0, PH1, PH2, PH3) Stubby (3, 3.5, 4, 5.5) Voltage Tester 145 mm	30		
9	Safety Goggles & Ear Muffs & gloves		100		
10	Steel Cantilever Tool Box	3 sections size 530x200x200mm.	40		
11	Multifunctional parts storage box	15-24 grid lattice adjustable tool box Size(Minimum): 29 x 20 x 2.5 cm	20		
12	26 Drawer Storage Cabinet	Size(Minimum): 50 x 20 x 16 cm	20		
13	Sockets sets 1/4" (Brand Name)	Reversible Ratchet With Quick release 1/4" 115-140 mm Bits 4, 4.5, 5, 5.5, 6, 7, 8, 9, 10, 11, 12, 13,14 Super-Torque Universel Joint 1/4" Sliding T-Handle 1/4" 115-200 mm Extension Bar 1/4" 30-60 mm Spinner Handle 135-150mm	30		
14	Combination Wrench Set (9 Piece) رنج-شاك	6,7,8,9,10,11,12,13,14	30		
15	Drill & Driver Set	40x 25mm Screwdriver bits1x 60mm bit holder3x Flat bits,7x Nutdrivers6x HSS drill bits6x Masonry wood bits4x Hole saws1x Arbor of hole saw6x Brad point1x Centre punch	30		
					
16	Step Drill Bit Set	3Pcs 4-12/4-20/4-32mm 1/4 Inch Hex Shank HSS	30		
					

Section IV. Bidding Forms

17	<b>Tool Hex Set(8 Piece)</b>	5/64", 3/32", 7/64", 1/8", 9/64", 5/32", 3/16", 7/32" and 1/4"	30		
18	<b>Hand saws set</b>	Hand saw for metal cutting 12" Hand copying saw L300-400 mm X D 200-300 mm Back Saw 300-400 mm Combination Saw 500 – 600 mm	30		
19	<b>Adjustable Wrenches set</b>	(3 Piece 10", 8", 6") 	30		
20	<b>Hot Glue Gun</b>	100 Watt at lest	30		
21	<b>Carpenters Square</b>	350-400mm	30		
22	<b>Bevel Gage</b>	200-250mm	30		
23	<b>Rasp 8"</b>	(10 Piece) 5 for Wood, 5 Steel 4 x Second Cut: 200 mm (8") Round, Hand, Square, Three Square. 1 x Bastard Cut: 200 mm (8") Half Round.	30		
24	<b>Smoothing Plane #4 (Brand Name)</b>		30		
25	<b>Hand Riveter</b> 	2.4-4mm & Aluminum Rivets : 3.2 Ø x 8mm	30		
26	<b>Wood Chisel Set</b> مجموعة إزميل الخشب	(4 piece: 20mm, 16mm, 12mm, 8 mm)	30		
27	<b>F Clamp</b>	(L 300mm X W 120mm)	80		
28	<b>Offset Tin Snips</b> 	(Cutting length 35mm, L 240mm)	30		
29	<b>Magnetic Torpedo Level</b>	Vials read plumb, level and 45 degrees Strong hold magnetic edge 	30		





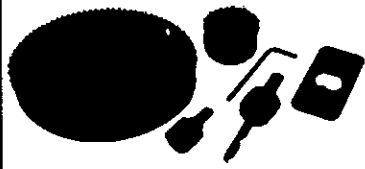

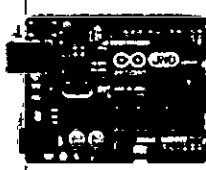
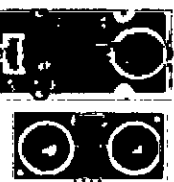

دولة فلسطين  
إدارة العامة للأوقاف والادارة  
وزارة المالية والتخطيط  
17-08-2022  
دائرة المعاملات المركزية

## Section IV. Bidding Forms

30	<b>Steel Bench Vise</b>	360° Swivel base, 5"		10		
31	<b>Clamp-on Vises</b>	360° Swivel base 3"		30		
32	<b>Staple Gun</b>			30		
33	<b>Hole Saw set</b>	Size: 19,22,25,38,28,44,54,63,75,88 mm Drill Bit Shank Diameter Bit Diameter		30		

Total of Group 2

**Group -3 Programmable Microcontroller & Robotics Tools**

1	<b>Electronic Kits of SEEK Basic Ver2 type or it's equivalents</b>			50		
2	<b>FIRST LEGO LEAGUE System</b>	<ul style="list-style-type: none"> <li>EV3 Core Set</li> <li>EV3 Expansion Set</li> <li>EV3 Software</li> </ul>		5		
3	<b>Arduino set</b>	<ol style="list-style-type: none"> <li>Arduino Uno</li> <li>L298N Stepper Motor Drive</li> <li>Bluetooth Module HC-05 or HC-06</li> <li>HC-SR04 Ultrasonic</li> <li>PIR Motion Sensor</li> <li>Thermal Sensor Module</li> <li>Double Digit Common Anode Display</li> <li>PS2 joystick module</li> <li>4x4 Keypad</li> </ol>	        	50		
4	<b>Jumper cables for arduino breadboard</b>	male/male (40 PCS at least) female/male (20 PCS at least) female/female (20 PCS at least)		50		

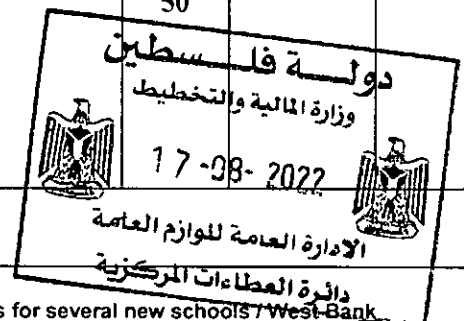

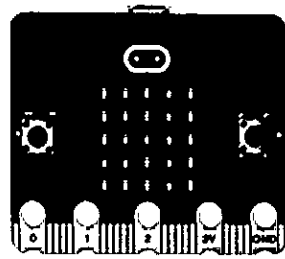
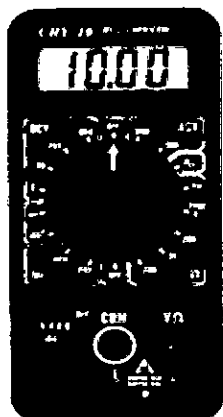

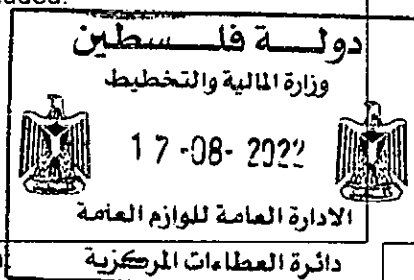
5	<b>Smart Robot Car Chassis Kit</b> 	2 x Gear Motor(1:48) 2 x Car Tire 2 x Speed Encoder 2 x Fastener 1 x Universal Wheel 1 x Battery Box 1 x Power Button	50		
6	<b>Microbit V2 as min</b>		100		
7	<b>Crawtail Kit</b>	Annex 1	25		
	<b>3D Printer</b>	Annex 2	5		
<b>Total of Group 3</b>					
<b>Group - 4 Electronic Tools</b>					
1	<b>Power Supply AC &amp; DC</b>	Output Voltages: range from 0.9V to 24V AC & DC/ 3A Output Current: 1x 0 + 3A Digital LED display, which shows the voltage or the current. Max. Power Consumption: 160 w	30		
2	<b>Brand Name Hand Held Digital Multi-meter</b> 	DC Voltage: 0.2V up to 1000 VAC Voltage : 2V up to 750 VDC Current : 2mA up to 10AAC Current rms: 20mA up to 10AResistance : 200ohm up to 200MohmCapacitance; 2nF up to 20MicFFrequency: 1Hz up to 20KHzTemp.: -40degC up to 1000degCLCD Display: 4digits as minContinuity beeper, Auto RangeCapacitance : 1nF to 9999µFTransistor TestDiode Test, Hold & data hold,Instruction manual, battery, & test leads must be included.	50		
3	<b>Test Board</b>	54 point X 12 point	100		
4	<b>Chemical Capacitors;</b>	1mic, 10mic	1500		



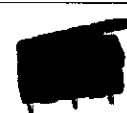

Section IV. Bidding Forms

5	<b>Ceramic Capacitors:</b>	10m, 0.1m, (2000 unit for each one)	1500		
6	<b>Resistors</b>	(10, 100, 220, 330, 470, 1K, 2K, 10K, 100K, 160K, 1M OHM) X 440 for each	1100		
7	<b>variable resistor</b>	22, 1K, 10K, 100K	1500		
8	<b>Voltage Dependent Resistor (VDR)</b>		500		
9	<b>Light Dependent Resistor (LDR)</b>		500		
10	<b>Diode:</b>	1N4007,1N4001	1000		
11	<b>Light Emitting LED:</b>	LED (Red, Orange, Green) - colors	2500		
12	<b>Zener Diode:</b>	V12 ,V, 5V3	1000		
13	<b>Thyrmistor</b>	220, 4K ohm - NTC	500		
14	<b>Switches</b>	ON/OFF, Push Button, SPDT, Toggle SPDT, Toggle DPDT 	500		
15	<b>Ic Timer,</b>	NE 555	250		
16	<b>Transistor:</b>	Bc147, BF451,BC548, 2N2222, TIP121	1080		
17	<b>IC TTL</b>	7400, 7402, 7404, 7408, 7428, 7432, 4017 COUNTER	625		
18	<b>IC</b>	IC LM386, IC LM324, IC LM311, IC LM35	300		
19	<b>LM 7805, 7812</b>		50		
20	<b>TDI 2003</b>		50		
21	<b>IR-</b>	Rx+Tx	200		
22	<b>7- Segment:</b>	1400 Common Anode,1400 Common Cathode	50		
23	<b>Relay</b>	6V DC 1Channel, 6V DC 2Channel. 	250		
24	<b>Microswitch with Lever</b>		60		
25	<b>Circuit breakers</b> مفاتيح الحماية	9 Pics: 25A + 20A +4 X 16A 2X10A +Earth Leakage 25A	10		
26	<b>Electrical Distribution Board</b>	12 ways, لوحة مفاتيح كهرباء	10		
27	<b>switch one, 3, 4 ways</b>	x6 مفتاح صليب + x12 مفتاح درج + x12 مفتاح مفرد	75		
<b>Total of Group 4</b>					
<b>Total prices \$ excluding VAT</b>					

دولة فلسطين  
وزارة المالية والتخطيط

17-08-2022

الإدارة العامة للاداء العامة  
for several new schools / West Bank  
دائرة العطاءات

● الشروط الخاصة

1. الإحالة حسب المجموعة.
2. مكان التوريد المدارس المستهدفة.
3. مدة التوريد 90 يوم عمل.

**Annex 1 Crawteil kit**

Shield for Micro: bit x1
LED (Yellow) x1
LED (Green) x1
Buzzer x1
Switch x1
Touch Sensor x1
Collision Sensor x1
Light Sensor x1
Moisture Sensor x1
PIR Motion Sensor x1
Ultrasonic Ranging Sensor x1
Linear Potentiometer x1
Temperature & Humidity Sensor x1
Relay x1
9G Servo x1
RTC x1
OLED x1
IR Receiver x1
Infrared Remote Control x1
L298N Dual H-Bridge Motor Drive Module Board

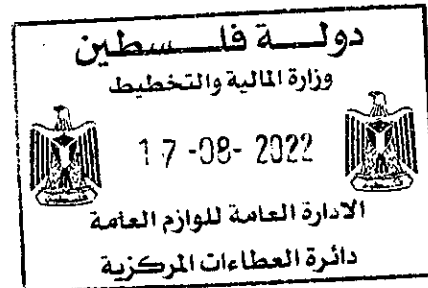

## Annex 2 3D Printer

3D printer advanced, Build Volume  
17.5x17.5x16.5CM  
More materials range  
Fully enclosed with an passively heated chamber up to 50C, the  
3D Printer is capable of printing with PLA, PETG, TOUGH PLA,  
ABS, Nylon, PC-ABS, and ASA build materials

## Key Features:

Fused Filament Fabrication (FFF) 3D Printer  
175 × 175 × 165 mm  
DIRECT DRIVE Material Extrusion, DUAL GEAR FEEDING HIGH  
TORQUE  
SMART FILAMENT FEEDER  
Enclosed build chamber and impressive dimensional accuracy  
AUTOMATIC LIGHT UP WITH BUILT IN LED BAR  
BUILT IN WEB CAMERA  
FULL APP TO MONITOR PRINTING AND SEND PRINTS ON THE  
GO

## Includes:

SPRITE PRO DIRECT DRIVE EXTRUDER  
DOUBLE SIDED Spring Steel Build Plate, Hex Key Tools  
Additional materials are available to buy separately

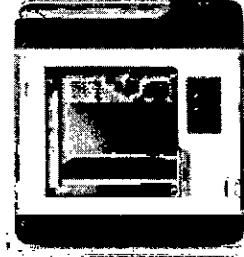

**Bid Security Form**

To: Ministry of Finance  
Palestinian Authority

Date: \_\_\_\_\_

Contract Name: Supply and Delivery of

Contract No.: **MOE/JFA/19.222425/2022/ 171**

Gentlemen and/or Ladies:

We, the undersigned ..... (Guarantor), in order to enable ..... to bid for (Tender for the purchase of equipment and tools for several new schools / West Bank) hereby irrevocably and independently guarantee to pay to you an amount up to a total of .....

(In words: .....)

Waiving all objections and defenses

We shall effect payments under this guarantee on your first written demand, which must be accompanied by your confirmation that you have accepted the above-mentioned bid and that the firm ..... is no longer prepared to abide by this bid.

This guarantee shall expire not later than .....

By this date we must have received any claims by letter or encoded telecommunication.

It is understood that you will return this guarantee to us on expiry or after payment of the total amount to be claimed hereunder.

This guarantee is governed by the law of the Palestinian Authority.

.....  
Place, date

.....  
Guarantor

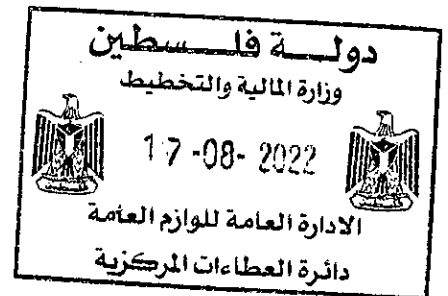

## Manufacturer's Authorization

[The Bidder shall require the Manufacturer to fill in this Form in accordance with the instructions indicated. This letter of authorization should be on the letterhead of the Manufacturer and should be signed by a person with the proper authority to sign documents that are binding on the Manufacturer. The Bidder shall include it in its bid, if so indicated in the **BDS.**]

Date: [insert date (as day, month and year) of Bid Submission]

NCB No.: [insert number of bidding process]

Alternative No.: [insert identification No if this is a Bid for an alternative]

To: [insert complete name of GSD]

### WHEREAS

We [insert complete name of Manufacturer], who are official manufacturers of [insert type of goods manufactured], having factories at [insert full address of Manufacturer's factories], do hereby authorize [insert complete name of Bidder] to submit a bid the purpose of which is to provide the following Goods, manufactured by us [insert name and or brief description of the Goods], and to subsequently negotiate and sign the Contract.

We hereby extend our full guarantee and warranty in accordance with Clause 27 of the General Conditions of Contract, with respect to the Goods offered by the above firm.

Signed: [insert signature(s) of authorized representative(s) of the Manufacturer]

Name: [insert complete name(s) of authorized representative(s) of the Manufacturer]

Title: [insert title]

Dated on \_\_\_\_\_ day of \_\_\_\_\_, \_\_\_\_\_ [insert date of signing]



## PART 2 – Supply Requirements



## Section VI. Schedule of Requirements

### Contents

Delivery Schedule .....	56
Technical Specifications .....	59
Drawings.....	71
Inspections and Tests .....	73

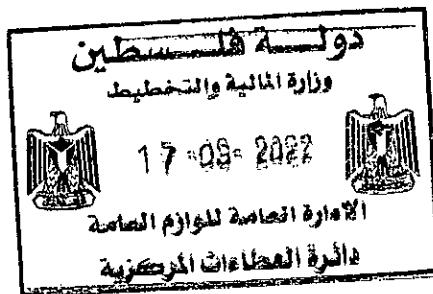

## 1. Delivery Schedule

Tender for the purchase of equipment and tools for several new schools / West Bank

Group1	Group2	Group3	Group4	الاسم بالانجليزي	اسم المدرسة	الرقم الوطني	المديرية	الرقم
1	1	1	1	Ali ben Abi Taleb	علي بن ابي طالب		جنوب الخليل	1
1	1	1	1	Om Almo'mneen Sec	ام المؤمنين الثانوية		يطا	2
1	1	1	1	Ertas Sec for boys	مدرسة ارتاس الثانوية للذكور		بيت لحم	3
1	1	1	1	Alaar Basic for Girls	مدرسة عرار الاساسية للبنات		طولكرم	4
1	1	1	1	Betillo Sec for Boys	بيتللو الثانوية للذكور		رام الله	5
5	5	5	5		المجموع الكلي			





### 3. Drawings

These Bidding Documents includes *[insert "the following" or "no"]* drawings.

List of Drawings		
Drawing Nr.	Drawing Name	Purpose



## 4. Inspections and Tests

The following inspections and tests shall be performed: *[insert list of inspections and tests]*



## PART 3 - Contract



## Section VII. General Conditions of Contract

### Table of Clauses

1. Definitions .....	60
2. Contract Documents .....	61
3. Fraud and Corruption .....	61
4. Interpretation .....	62
5. Language .....	63
6. Joint Venture, Consortium or Association .....	63
7. Eligibility .....	63
8. Notices .....	63
9. Governing Law .....	64
10. Settlement of Disputes .....	64
11. Scope of Supply .....	64
12. Delivery and Documents .....	64
13. Supplier's Responsibilities .....	65
14. Contract Price .....	65
15. Terms of Payment .....	65
16. Taxes and Duties .....	65
17. Performance Security .....	66
18. Copyright .....	66
19. Confidential Information .....	66
20. Subcontracting .....	67
21. Specifications and Standards .....	67
22. Packing and Documents .....	68
23. Insurance .....	68
24. Transportation .....	69
25. Inspections, Tests and Samples .....	69
26. Liquidated Damages .....	70
27. Warranty .....	70
28. Patent Indemnity .....	71
29. Limitation of Liability .....	72
30. Change in Laws and Regulations .....	72
31. Force Majeure .....	73
32. Change Orders and Contract Amendments .....	73
33. Extensions of Time .....	74
34. Termination .....	74
35. Assignment .....	76
36. Export Restriction .....	76

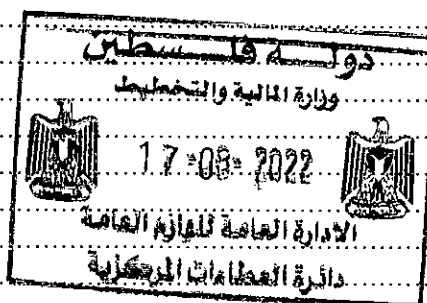

## Section VII. General Conditions of Contract

### 1. Definitions

- 1.1 The following words and expressions shall have the meanings hereby assigned to them:
- (a) "Contract" means the Contract Agreement entered into between the GSD (on behalf of the MOE) and the Supplier, together with the Contract Documents referred to therein, including all attachments, appendices, and all documents incorporated by reference therein.
  - (b) "Contract Documents" means the documents listed in the Contract Agreement, including any amendments thereto.
  - (c) "Contract Price" means the price payable to the Supplier as specified in the Contract Agreement, subject to such additions and adjustments thereto or deductions therefrom, as may be made pursuant to the Contract.
  - (d) "Day" means calendar day.
  - (e) "Completion" means the fulfillment of the Related Services by the Supplier in accordance with the terms and conditions set forth in the Contract.
  - (f) "GCC" means the General Conditions of Contract.
  - (g) "Goods" means all of the commodities, raw material, machinery and equipment, and/or other materials that the Supplier is required to supply to the MOE under the Contract.
  - (h) "GSD's Country" is the country specified in the Special Conditions of Contract (SCC).
  - (i) "GSD" means the entity purchasing the Goods and Related Services for the benefit of the MOE, as specified in the SCC.
  - (j) "MOE" means the entity benefiting from the purchasing process and managing this Contract.
  - (k) "Related Services" means the services incidental to the supply of the goods, such as insurance, installation, training and initial maintenance and other such obligations of the Supplier under the Contract.



## Section VII. General Conditions of Contract

- (l) "SCC" means the Special Conditions of Contract.
- (m) "Subcontractor" means any natural person, private or government entity, or a combination of the above, to whom any part of the Goods to be supplied or execution of any part of the Related Services is subcontracted by the Supplier.
- (n) "Supplier" means the natural person, private or government entity, or a combination of the above, whose bid to perform the Contract has been accepted by the GSD and is named as such in the Contract Agreement.
- (o) "The Project Site," where applicable, means the place named in the SCC.

### 2. Contract Documents

- 2.1 Subject to the order of precedence set forth in the Contract Agreement, all documents forming the Contract (and all parts thereof) are intended to be correlative, complementary, and mutually explanatory. The Contract Agreement shall be read as a whole.

### 3. Fraud and Corruption

- 3.1 If the GSD determines that the Supplier has engaged in corrupt, fraudulent, collusive, coercive or obstructive practices, in competing for or in executing the Contract, then the GSD may, after giving 14 days notice to the Supplier, terminate the Supplier's employment under the Contract and cancel the contract, and the provisions of Clause 34 shall apply as if such expulsion had been made under Sub-Clause 34.1.

- (a) For the purposes of this Sub-Clause:

- (i) "corrupt practice" is the offering, giving, receiving or soliciting, directly or indirectly, of anything of value to influence improperly the actions of another party;
- (ii) "fraudulent practice" is any act or omission, including a misrepresentation, that knowingly or recklessly misleads, or attempts to mislead, a party to obtain a financial or other benefit or to avoid an obligation;
- (iii) "collusive practice" is an arrangement between two or more parties designed to achieve an improper purpose, including to influence improperly the actions of another party;
- (iv) "coercive practice" is impairing or harming, or threatening to impair or harm, directly or

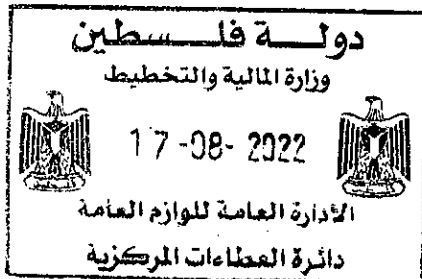

## Section VII. General Conditions of Contract

indirectly, any party or the property of the party to influence improperly the actions of a party;

- (v) “obstructive practice” is
- (aa) deliberately destroying, falsifying, altering or concealing of evidence material to the investigation or making false statements to investigators in order to materially impede investigation into allegations of a corrupt, fraudulent, coercive or collusive practice; and/or threatening, harassing or intimidating any party to prevent it from disclosing its knowledge of matters relevant to the investigation or from pursuing the investigation; or

3.2 Should any employee of the Supplier be determined to have engaged in corrupt, fraudulent, collusive, coercive, or obstructive practice during the purchase of the Goods, then that employee shall be removed.

### 4. Interpretation

4.1 If the context so requires it, singular means plural and vice versa.

4.2 Entire Agreement

The Contract constitutes the entire agreement between the GSD and the Supplier and supersedes all communications, negotiations and agreements (whether written or oral) of the parties with respect thereto made prior to the date of Contract.

4.3 Amendment

No amendment or other variation of the Contract shall be valid unless it is in writing, is dated, expressly refers to the Contract, and is signed by a duly authorized representative of each party thereto.

4.4 Nonwaiver

(a) Subject to GCC Sub-Clause 4.4(b) below, no relaxation, forbearance, delay, or indulgence by either party in enforcing any of the terms and conditions of the Contract or the granting of time by either party to the other shall prejudice, affect, or restrict the rights of that party under the Contract, neither shall any waiver by either party of any breach of Contract operate as waiver of any subsequent or continuing breach of Contract.

(b) Any waiver of a party’s rights, powers, or remedies under the Contract must be in writing, dated, and signed by an



## Section VII. General Conditions of Contract

authorized representative of the party granting such waiver, and must specify the right and the extent to which it is being waived.

### 4.5 Severability

If any provision or condition of the Contract is prohibited or rendered invalid or unenforceable, such prohibition, invalidity or unenforceability shall not affect the validity or enforceability of any other provisions and conditions of the Contract.

## 5. Language

5.1 The Contract as well as all correspondence and documents relating to the Contract exchanged by the Supplier and the GSD, shall be written in the language specified in the SCC. Supporting documents and printed literature that are part of the Contract may be in another language provided they are accompanied by an accurate translation of the relevant passages in the language specified, in which case, for purposes of interpretation of the Contract, this translation shall govern.

5.2 The Supplier shall bear all costs of translation to the governing language and all risks of the accuracy of such translation, for documents provided by the Supplier.

## 6. Joint Venture, Consortium or Association

6.1 If the Supplier is a joint venture, consortium, or association, all of the parties shall be jointly and severally liable to the GSD for the fulfillment of the provisions of the Contract and shall designate one party to act as a leader with authority to bind the joint venture, consortium, or association. The composition or the constitution of the joint venture, consortium, or association shall not be altered without the prior consent of the GSD.

## 7. Eligibility

7.1 The Supplier and its Subcontractors shall have the nationality of an eligible country. A Supplier or Subcontractor shall be deemed to have the nationality of a country if it is a citizen or constituted, incorporated, or registered, and operates in conformity with the provisions of the laws of that country.

7.2 All Goods and Related Services to be supplied under the Contract shall have their origin in Eligible Countries. For the purpose of this Clause, origin means the country where the goods have been grown, mined, cultivated, produced, manufactured, or processed; or through manufacture, processing, or assembly, another commercially recognized article results that differs substantially in its basic characteristics from its components.

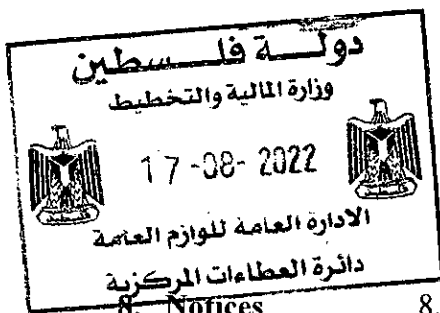

## 8. Notices

8.1 Any notice given by one party to the other pursuant to the Contract shall be in writing to the address specified in the SCC. The term "in writing" means communicated in written



## Section VII. General Conditions of Contract

form with proof of receipt.

8.2 A notice shall be effective when delivered or on the notice's effective date, whichever is later.

**9. Governing Law** 9.1 The Contract shall be governed by and interpreted in accordance with the laws of the MOE's Country, unless otherwise specified in the SCC.

**10. Settlement of Disputes** 10.1 The GSD and the Supplier shall make every effort to resolve amicably by direct informal negotiation any disagreement or dispute arising between them under or in connection with the Contract.

10.2 If, after twenty-eight (28) days, the parties have failed to resolve their dispute or difference by such mutual consultation, then either the GSD or the Supplier may give notice to the other party of its intention to commence arbitration, as hereinafter provided, as to the matter in dispute, and no arbitration in respect of this matter may be commenced unless such notice is given. Any dispute or difference in respect of which a notice of intention to commence arbitration has been given in accordance with this Clause shall be finally settled by arbitration. Arbitration may be commenced prior to or after delivery of the Goods under the Contract. Arbitration proceedings shall be conducted in accordance with the rules of procedure **specified in the SCC**.

10.3 Notwithstanding any reference to arbitration herein,

(a) The parties shall continue to perform their respective obligations under the Contract unless they otherwise agree; and

(b) The MOE shall pay the Supplier any monies due the Supplier.

11.1 The Goods and Related Services to be supplied shall be as specified in the Price Schedule.

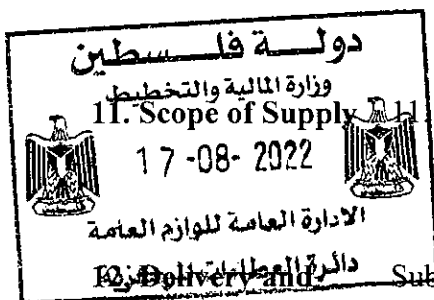

Subject to GCC Sub-Clause 31.1, the Delivery of the Goods and Completion of the Related Services shall be in accordance with the Delivery Schedule specified in the Schedule of Requirements. The

details of shipping and other documents to be furnished by the Supplier are specified in the SCC.

**13. Supplier's Responsibilities**

13.1 The Supplier shall supply all the Goods and Related Services included in the Scope of Supply in accordance with GCC Clause 11, and the Delivery Schedule, as per GCC Clause 12.

**14. Contract Price**

14.1 Prices charged by the Supplier for the Goods supplied and the Related Services performed under the Contract shall not vary from the prices quoted by the Supplier in its bid, with the exception of any price adjustments authorized in the SCC.

**15. Terms of Payment**

15.1 The Contract Price, including any Advance Payments, if applicable, shall be paid as specified in the SCC.

15.2 The Supplier's request for payment shall be made to the GSD in writing, accompanied by invoices describing, as appropriate, the Goods delivered and Related Services performed, and by the documents submitted pursuant to GCC Clause 13 and upon fulfillment of all other obligations stipulated in the Contract.

15.3 Payments shall be made promptly by the MOE, but in no case later than sixty (60) days after submission of an invoice or request for payment by the Supplier, and after the MOE has accepted it.

15.4 The currencies in which payments shall be made to the Supplier under this Contract shall be those in which the bid price is expressed.

15.5 In the event that the MOE fails to pay the Supplier any payment by its due date or within the period set forth in the SCC, the MOE shall pay to the Supplier interest on the amount of such delayed payment at the rate shown in the SCC, for the period of delay until payment has been made in full, whether before or after judgment or arbitration award.

**16. Taxes and Duties**

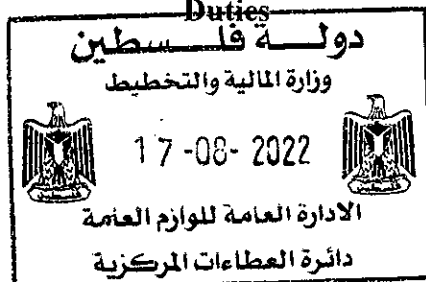

16.1 For goods manufactured outside the MOE's Country, the Supplier shall be entirely responsible for all taxes, stamp duties, license fees, and other such levies imposed outside and inside the MOE's Country incurred until delivery of the contracted Goods to the GSD excluding the VAT.

16.2 For goods Manufactured within the MOE

## Section VII. General Conditions of Contract

's country, the Supplier shall be entirely responsible for all taxes, duties, license fees, etc., incurred until delivery of the contracted Goods to the MOE excluding the VAT.

### 17. Performance Security

- 17.1 The Supplier shall, within fourteen (14) days of the notification of contract award, provide a performance security for the performance of the Contract in the amount specified in the SCC.
- 17.2 The Performance Security shall be issued by a reputable institution selected by the bidder and approved by the GSD and located in any eligible country. If the institution issuing the security is located outside the MOE's Country, it shall have a correspondent financial institution located in the MOE's Country to make it enforceable. The Bid Security shall comply with the rules of the Palestinian Monetary Authority.
- 17.3 The proceeds of the Performance Security shall be payable to the GSD as compensation for any loss resulting from the Supplier's failure to complete its obligations under the Contract.
- 17.4 As specified in the SCC, the Performance Security shall be denominated in the currency of the Contract, and shall be in the format stipulated by the GSD in Section IX – Contract Forms.
- 17.5 The Performance Security shall be discharged by the GSD and returned to the Supplier not later than twenty-eight (28) days following the date of Completion of the Supplier's performance obligations under the Contract, including any warranty obligations, unless specified otherwise in the SCC.



The copyright in all drawings, documents, and other materials containing data and information furnished to the GSD by the Supplier herein shall remain vested in the Supplier, or, if they are furnished to the MOE directly or through the Supplier by any third party, including suppliers of materials, the copyright in such materials shall remain vested in such third party

The GSD and the Supplier shall keep confidential and shall not, without the written consent of the other party hereto,

## Section VII. General Conditions of Contract

divulge to any third party any documents, data, or other information furnished directly or indirectly by the other party hereto in connection with the Contract, whether such information has been furnished prior to, during or following completion or termination of the Contract. Notwithstanding the above, the Supplier may furnish to its Subcontractor such documents, data, and other information it receives from the GSD to the extent required for the Subcontractor to perform its work under the Contract, in which event the Supplier shall obtain from such Subcontractor an undertaking of confidentiality similar to that imposed on the Supplier under GCC Clause 19.

19.2 The GSD shall not use such documents, data, and other information received from the Supplier for any purposes unrelated to the contract. Similarly, the Supplier shall not use such documents, data, and other information received from the GSD for any purpose other than the performance of the Contract.

19.3 The obligation of a party under GCC Sub-Clauses 19.1 and 20.2 above, however, shall not apply to information that:

- (a) Now or hereafter enters the public domain through no fault of that party;
- (b) Can be proven to have been possessed by that party at the time of disclosure and which was not previously obtained, directly or indirectly, from the other party; or
- (c) Otherwise lawfully becomes available to that party from a third party that has no obligation of confidentiality.

19.4 The above provisions of GCC Clause 19 shall not in any way modify any undertaking of confidentiality given by either of the parties hereto prior to the date of the Contract in respect of the Supply or any part thereof.

19.5 The provisions of GCC Clause 19 shall survive completion or termination, for whatever reason, of the Contract.

### 20. Subcontracting

20.1 The Supplier shall notify the GSD in writing of all subcontracts awarded under the Contract if not already specified in the bid. Such notification, in the original bid or later shall not relieve the Supplier from any of its obligations, duties, responsibilities, or liability under the Contract.

Subcontracts shall comply with the provisions of GCC Clauses 3 and 7.



### 21. Specifications

21.1 Technical Specifications and Drawings

and Standards

- (a) The Goods and Related Services supplied under this Contract shall conform to the technical specifications and standards mentioned in Section VI, Schedule of Requirements and, when no applicable standard is mentioned, the standard shall be equivalent or superior to the official standards whose application is appropriate to the Goods' country of origin.
- (b) The Supplier shall be entitled to disclaim responsibility for any design, data, drawing, specification or other document, or any modification thereof provided or designed by or on behalf of the GSD, by giving a notice of such disclaimer to the GSD.
- (c) Wherever references are made in the Contract to codes and standards in accordance with which it shall be executed, the edition or the revised version of such codes and standards shall be those specified in the Schedule of Requirements. During Contract execution, any changes in any such codes and standards shall be applied only after approval by the GSD and shall be treated in accordance with GCC Clause 32.

22. Packing and Documents

- 22.1 The Supplier shall provide such packing of the Goods as is required to prevent their damage or deterioration during transit to their final destination, as indicated in the Contract. During transit, the packing shall be sufficient to withstand, without limitation, rough handling and exposure to extreme temperatures, salt and precipitation, and open storage. Packing case size and weights shall take into consideration, where appropriate, the remoteness of the goods' final destination and the absence of heavy handling facilities at all points in transit.
- 22.2 The packing, marking, and documentation within and outside the packages shall comply strictly with such special requirements as shall be expressly provided for in the Contract, including additional requirements, if any, specified in the SCC, and in any other instructions ordered by the GSD.

23. Insurance

- 23.1 Unless otherwise specified in the SCC, the Goods supplied under the Contract shall be fully insured—in a freely convertible currency from an eligible country—against loss or damage incidental to manufacture or acquisition, transportation, storage, and delivery, in accordance with the manner specified in the SCC.



- 23.2 Notwithstanding the Supplier's insurance obligations under Article 23.1 the Supplier shall bear sole liability for, and

## Section VII. General Conditions of Contract

indemnify the GSD against, any claims for damage to property or personal injuries arising from the execution of the contract by the Supplier, his subcontractors and their employees.

- 24. Transportation** The responsibility for arranging transportation of the Goods shall be of the Supplier.
- 25. Inspections, Tests and Samples**
- 25.1 During tender action significant descriptions supported by pictures (leaflets) shall be attached to the BQ documents explaining technical specifications of items offered.
- 25.2 In order to verify quality of product for final award decision it might be required to provide original samples at a later stage.
- 25.3 If requested samples of items shall be delivered to the GSD in Ramallah.
- 25.4 Under no circumstances claims for transport from and back to the Supplier will be accepted by the Employer.
- 25.5 The Supplier shall at its own expense and at no cost to the GSD carry out all such tests and/or inspections of the Goods and Related Services as are specified in the SCC.
- 25.6 The inspections and tests may be conducted on the premises of the Supplier or its Subcontractor, at point of delivery, and/or at the Goods' final destination, or in another place in the MOE's Country as specified in the SCC. Subject to GCC Sub-Clause 25.7, if conducted on the premises of the Supplier or its Subcontractor, all reasonable facilities and assistance, including access to drawings and production data, shall be furnished to the inspectors at no charge to the GSD.
- 25.7 The GSD or its designated representative shall be entitled to attend the tests and/or inspections referred to in GCC Sub-Clause 25.6, provided that the GSD bear all of its own costs and expenses incurred in connection with such attendance including, but not limited to, all traveling and board and lodging expenses.
- Whenever the Supplier is ready to carry out any such test and inspection, it shall give a reasonable advance notice, including the place and time, to the GSD. The Supplier shall obtain from any relevant third party or manufacturer any necessary permission or consent to enable the GSD or its designated representative to attend the test and/or inspection.
- 25.9 The GSD may require the Supplier to carry out any test and/or inspection not required by the Contract but deemed necessary to verify that the characteristics and performance of the Goods

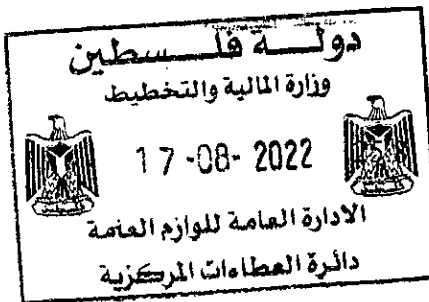

## Section VII. General Conditions of Contract

comply with the technical specifications codes and standards under the Contract, provided that the Supplier's reasonable costs and expenses incurred in the carrying out of such test and/or inspection shall be added to the Contract Price. Further, if such test and/or inspection impedes the progress of manufacturing and/or the Supplier's performance of its other obligations under the Contract, due allowance will be made in respect of the Delivery Dates and Completion Dates and the other obligations so affected.

- 25.10 The Supplier shall provide the GSD with a report of the results of any such test and/or inspection.
- 25.11 The GSD may reject any Goods or any part thereof that fail to pass any test and/or inspection or do not conform to the specifications. The Supplier shall either rectify or replace such rejected Goods or parts thereof or make alterations necessary to meet the specifications at no cost to the GSD, and shall repeat the test and/or inspection, at no cost to the GSD, upon giving a notice pursuant to GCC Sub-Clause 25.8
- 25.12 The Supplier agrees that neither the execution of a test and/or inspection of the Goods or any part thereof, nor the attendance by the GSD or its representative, nor the issue of any report pursuant to GCC Sub-Clause 25.10, shall release the Supplier from any warranties or other obligations under the Contract.

### 26. Liquidated Damages

- 26.1 Except as provided under GCC Clause 31, if the Supplier fails to deliver any or all of the Goods by the Date(s) of delivery or perform the Related Services within the period specified in the Contract, the GSD may without prejudice to all its other remedies under the Contract, deduct from the Contract Price, as liquidated damages, a sum equivalent to the percentage specified in the SCC of the delivered price of the delayed Goods or unperformed Services for each week or part thereof of delay until actual delivery or performance, up to a maximum deduction of the percentage specified in those SCC. Once the maximum is reached, the GSD may terminate the Contract pursuant to GCC Clause 34.

### 27. Warranty

- 27.1 The Supplier warrants that all the Goods are new, unused, and of the most recent or current models, and that they incorporate all recent improvements in design and materials, unless provided otherwise in the Contract.

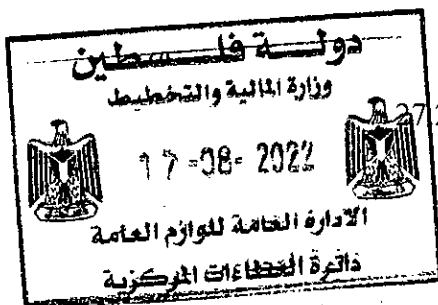

- 27.2 Subject to GCC Sub-Clause 21.1(b), the Supplier further warrants that the Goods shall be free from defects arising from any act or omission of the Supplier or arising from design, materials, and workmanship, under normal use in the

conditions prevailing in the country of final destination.

- 27.3 Unless otherwise specified in the SCC, the warranty shall remain valid for twelve (12) months after the Goods, or any portion thereof as the case may be, have been delivered to and accepted at the final destination indicated in the SCC.
- 27.4 The GSD shall give notice to the Supplier stating the nature of any such defects together with all available evidence thereof, promptly following the discovery thereof. The GSD shall afford all reasonable opportunity for the Supplier to inspect such defects.
- 27.5 Upon receipt of such notice, the Supplier shall, within the period specified in the SCC, expeditiously repair or replace the defective Goods or parts thereof, at no cost to the GSD.
- 27.6 If having been notified, the Supplier fails to remedy the defect within the period specified in the SCC, the MOE may proceed to take within a reasonable period such remedial action as may be necessary, at the Supplier's risk and expense and without prejudice to any other rights which the GSD may have against the Supplier under the Contract.

**28. Patent  
Indemnity**

- 28.1 The Supplier shall, subject to the GSD's compliance with GCC Sub-Clause 28.2, indemnify and hold harmless the GSD and its employees and officers from and against any and all suits, actions or administrative proceedings, claims, demands, losses, damages, costs, and expenses of any nature, including attorney's fees and expenses, which the GSD may suffer as a result of any infringement or alleged infringement of any patent, utility model, registered design, trademark, copyright, or other intellectual property right registered or otherwise existing at the date of the Contract by reason of:
- (a) The installation of the Goods by the Supplier or the use of the Goods in the country where the Site is located; and
- (b) The sale in any country of the products produced by the Goods.

Such indemnity shall not cover any use of the Goods or any part thereof other than for the purpose indicated by or to be reasonably inferred from the Contract, neither any infringement resulting from the use of the Goods or any part thereof, or any products produced thereby in association or combination with any other equipment, plant, or materials not supplied by the Supplier, pursuant to the Contract.

- 28.2 If any proceedings are brought or any claim is made against the GSD arising out of the matters referred to in GCC Sub-Clause





## Section VII. General Conditions of Contract

28.1, the GSD shall promptly give the Supplier a notice thereof, and the Supplier may at its own expense and in the GSD's name conduct such proceedings or claim and any negotiations for the settlement of any such proceedings or claim.

28.3 If the Supplier fails to notify the GSD within twenty-eight (28) days after receipt of such notice that it intends to conduct any such proceedings or claim, then the GSD shall be free to conduct the same on its own behalf.

28.4 The GSD shall, at the Supplier's request, afford all available assistance to the Supplier in conducting such proceedings or claim, and shall be reimbursed by the Supplier for all reasonable expenses incurred in so doing.

28.5 The GSD shall indemnify and hold harmless the Supplier and its employees, officers, and Subcontractors from and against any and all suits, actions or administrative proceedings, claims, demands, losses, damages, costs, and expenses of any nature, including attorney's fees and expenses, which the Supplier may suffer as a result of any infringement or alleged infringement of any patent, utility model, registered design, trademark, copyright, or other intellectual property right registered or otherwise existing at the date of the Contract arising out of or in connection with any design, data, drawing, specification, or other documents or materials provided or designed by or on behalf of the GSD.

### 29. Limitation of Liability

29.1 Except in cases of criminal negligence or willful misconduct,

(a) the Supplier shall not be liable to the GSD, whether in contract, tort, or otherwise, for any indirect or consequential loss or damage, loss of use, loss of production, or loss of profits or interest costs, provided that this exclusion shall not apply to any obligation of the Supplier to pay liquidated damages to the GSD and



the aggregate liability of the Supplier to the GSD, whether under the Contract, in tort or otherwise, shall not exceed the total Contract Price, provided that this limitation shall not apply to the cost of repairing or replacing defective equipment, or to any obligation of the supplier to indemnify the GSD with respect to patent infringement

### 30. Change in Laws and Regulations

30.1 Unless otherwise specified in the Contract, if after the date of 28 days prior to date of Bid submission, any law, regulation, ordinance, order or bylaw having the force of law is enacted,

promulgated, abrogated, or changed in the Palestinian Territories where the Site is located (which shall be deemed to include any change in interpretation or application by the competent authorities) that subsequently affects the Delivery Date and/or the Contract Price, then such Delivery Date and/or Contract Price shall be correspondingly increased or decreased, to the extent that the Supplier has thereby been affected in the performance of any of its obligations under the Contract. Notwithstanding the foregoing, such additional or reduced cost shall not be separately paid or credited if the same has already been accounted for in the price adjustment provisions where applicable, in accordance with GCC Clause 14.

**31. Force Majeure**

- 31.1 The Supplier shall not be liable for forfeiture of its Performance Security, liquidated damages, or termination for default if and to the extent that its delay in performance or other failure to perform its obligations under the Contract is the result of an event of Force Majeure.
- 31.2 For purposes of this Clause, "Force Majeure" means an event or situation beyond the control of the Supplier that is not foreseeable, is unavoidable, and its origin is not due to negligence or lack of care on the part of the Supplier. Such events may include, but not be limited to, acts of the GSD in its sovereign capacity, wars or revolutions, fires, floods, epidemics, quarantine restrictions, and freight embargoes.
- 31.3 If a Force Majeure situation arises, the Supplier shall promptly notify the GSD in writing of such condition and the cause thereof. Unless otherwise directed by the GSD in writing, the Supplier shall continue to perform its obligations under the Contract as far as is reasonably practical, and shall seek all reasonable alternative means for performance not prevented by the Force Majeure event.

**32. Change Orders and Contract Amendments**

- 32.1 The GSD may at any time order the Supplier through notice in accordance GCC Clause 8, to make changes within the general scope of the Contract in any one or more of the following:
- Drawings, designs, or specifications, where Goods to be furnished under the Contract are to be specifically manufactured for the GSD;
  - The method of shipment or packing;
  - The place of delivery; and
  - The Related Services to be provided by the Supplier.

- 32.2 If any such change causes an increase or decrease in the cost

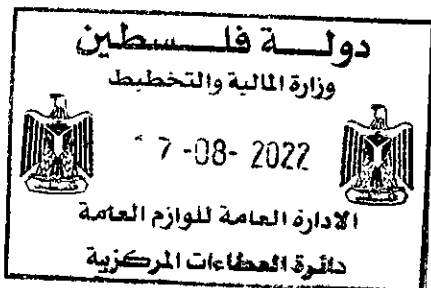

of, or the time required for, the Supplier's performance of any provisions under the Contract, an equitable adjustment shall be made in the Contract Price or in the Delivery/Completion Schedule, or both, and the Contract shall accordingly be amended. Any claims by the Supplier for adjustment under this Clause must be asserted within twenty-eight (28) days from the date of the Supplier's receipt of the GSD's change order.

32.3 Prices to be charged by the Supplier for any Related Services that might be needed but which were not included in the Contract shall be agreed upon in advance by the parties and shall not exceed the prevailing rates charged to other parties by the Supplier for similar services.

32.4 Subject to the above, no variation in or modification of the terms of the Contract shall be made except by written amendment signed by the parties.

### 33. Extensions of Time

33.1 If at any time during performance of the Contract, the Supplier or its subcontractors should encounter conditions impeding timely delivery of the Goods or completion of Related Services pursuant to GCC Clause 12, the Supplier shall promptly notify the GSD in writing of the delay, its likely duration, and its cause. As soon as practicable after receipt of the Supplier's notice, the GSD shall evaluate the situation and may at its discretion extend the Supplier's time for performance, in which case the extension shall be ratified by the parties by amendment of the Contract.

33.2 Except in case of Force Majeure, as provided under GCC Clause 31, a delay by the Supplier in the performance of its Delivery and Completion obligations shall render the Supplier liable to the imposition of liquidated damages pursuant to GCC Clause 25, unless an extension of time is agreed upon, pursuant to GCC Sub-Clause 33.1.

### 34. Termination

34.1 Termination for Default

(a) The GSD, without prejudice to any other remedy for breach of Contract, by written notice of default sent to the Supplier, may terminate the Contract in whole or in part:

- (i) if the Supplier fails to deliver any or all of the Goods within the period specified in the Contract, or within any extension thereof granted by the GSD pursuant to GCC Clause 33;
- (ii) if the Supplier fails to perform any other obligation



## Section VII. General Conditions of Contract

under the Contract; or

- (iii) if the Supplier, in the judgment of the GSD has engaged in fraud and corruption, as defined in GCC Clause 3, in competing for or in executing the Contract.
- (b) In the event the GSD terminates the Contract in whole or in part, pursuant to GCC Clause 34.1(a), the GSD may procure, upon such terms and in such manner as it deems appropriate, Goods or Related Services similar to those undelivered or not performed, and the Supplier shall be liable to the GSD for any additional costs for such similar Goods or Related Services. However, the Supplier shall continue performance of the Contract to the extent not terminated.

### 34.2 Termination for Insolvency.

- (a) The GSD may at any time terminate the Contract by giving notice to the Supplier if the Supplier becomes bankrupt or otherwise insolvent. In such event, termination will be without compensation to the Supplier, provided that such termination will not prejudice or affect any right of action or remedy that has accrued or will accrue thereafter to the GSD

### 34.3 Termination for Convenience.

- (a) The GSD, by notice sent to the Supplier, may terminate the Contract, in whole or in part, at any time for its convenience. The notice of termination shall specify that termination is for the GSD's convenience, the extent to which performance of the Supplier under the Contract is terminated, and the date upon which such termination becomes effective.
- (b) The Goods that are complete and ready for shipment within twenty-eight (28) days after the Supplier's receipt of notice of termination shall be accepted by the GSD at the Contract terms and prices. For the remaining Goods, the GSD may elect:
  - (i) to have any portion completed and delivered at the Contract terms and prices; and/or
  - (ii) to cancel the remainder and pay to the Supplier an agreed amount for partially completed Goods and Related Services and for materials and parts previously procured by the Supplier.



## Section VII. General Conditions of Contract

### 35. Assignment

Neither the GSD nor the Supplier shall assign, in whole or in part, their obligations under this Contract, except with prior written consent of the other party.

### 36. Export Restriction

36.1 The Palestinian Authority has no control on borders, ports or airports as these are totally controlled by Israel. As a result, the GSD has no responsibility of any kind for any trade regulations, restrictions on import or export, delays, rejections or difficulties imposed by Israel or the Israelis.

36.2 However, the Supplier can demonstrate to the satisfaction of the GSD that it has completed all formalities in a timely manner, including applying for permits, authorizations and licenses necessary for the export of the products/goods, systems or services under the terms of the Contract. Termination of the Contract on this basis shall be for the GSD's convenience pursuant to Sub-Clause 34.3.

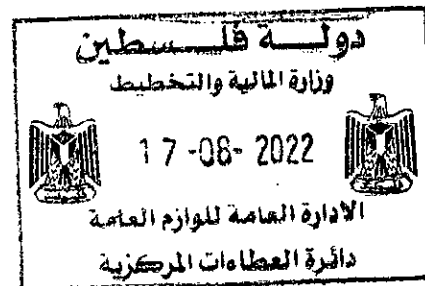

## Section VIII. Special Conditions of Contract

The following Special Conditions of Contract (SCC) shall supplement and / or amend the General Conditions of Contract (GCC). Whenever there is a conflict, the provisions herein shall prevail over those in the GCC.

<b>GCC 1.1(h)</b>	The GSD's country are the "State of Palestine"
<b>GCC 1.1(i)</b>	The GSD: The General Supplies Department State of Palestine
<b>GCC 1.1 (j)</b>	MOE : The Ministry of Education State of Palestine
<b>GCC 1.1 (o)</b>	The Project Site(s)/Final Destination(s) is/are: as furnished in the Delivery Schedule
<b>GCC 5.1</b>	The language shall be: English
<b>GCC 8.1</b>	For <b>notices</b> , the MOE's address shall be: Attention: Mohammad Al-Quarout Director of Procurement Department Ministry of Education  Old Building, Second Floor, Room # (23) Ramallah, P.O. BOX ( 576 ) Telephone: 02-2983243 Facsimile number: Electronic mail address:  For <b>notices</b> ; the Supplier's address shall be:
	
<b>GCC 9.1</b>	The governing law shall be the laws of the State of Palestine
<b>GCC 10.2</b>	The rules of procedure for arbitration proceedings pursuant to GCC Clause 10.2 shall be as follows:

Section IX. Contract Forms

	<p><b>(a) Contract with a Foreign Supplier:</b></p> <p>GCC 10.2 (a) Any dispute, controversy or claim arising out of or relating to this Contract, or breach, termination or invalidity thereof, shall be settled by arbitration in accordance with the UNCITRAL Arbitration Rules as at present in force ((see: <a href="http://www.uncitral.org/pdf/english/texts/arbitration/arb-rules-revised/arb-rules-revised-2010-e.pdf">http://www.uncitral.org/pdf/english/texts/arbitration/arb-rules-revised/arb-rules-revised-2010-e.pdf</a>).</p> <p>The place of arbitration shall be Ramallah and the Language of Arbitration shall be English.</p> <p><b>(b) Contracts with Suppliers being registered or based in the Palestinian Territories:</b></p> <p>In the case of a dispute between the GSD and a Supplier who is registered or based in the Palestinian Territories, the dispute shall be referred to adjudication or arbitration in accordance with the laws of the Palestinian Authority.</p>
<p><b>GCC 11.1</b></p>	<p>Details of Shipping and other Documents to be furnished by the Supplier are:</p> <p><b>For Goods supplied from abroad:</b></p> <p>GCC 10.3 Upon shipment, the Supplier shall notify the Purchaser of the full details of the shipment, including Contract number, description of Goods, quantity, the vessel, the bill of lading (number and date), port of loading, date of shipment, port of discharge, etc. The Supplier shall mail the following documents to the Purchaser, with a copy to the Insurance Company:</p> <ul style="list-style-type: none"> <li>(i) Copies of the Supplier's invoice showing Goods' description, quantity, unit price, and total amount;</li> <li>(ii) Original and (1) copy of the negotiable, clean, on-board bill of lading marked "freight prepaid" and (1) copy of nonnegotiable bill of lading;</li> <li>(iii) Copies of the packing list identifying contents of each package;</li> <li>(v) Manufacturer's or Supplier's warranty certificate;</li> <li>(vi) Certificate of origin.</li> </ul> <p>The above documents shall be received by the Purchaser at an adequate time before arrival of the Goods at the port or place of arrival and, if not received, the Supplier will be responsible for any consequent expenses.</p>

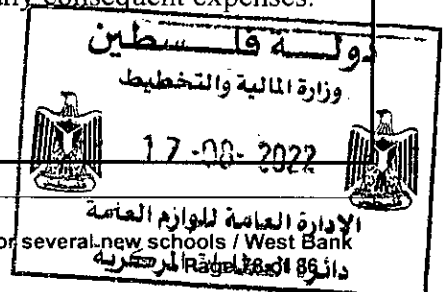

	<p><b>For Goods from within the Purchaser's country:</b></p> <p>GCC 10.3 Upon delivery of the Goods to the transporter, the Supplier shall notify the Purchaser and mail the following documents to the Purchaser:</p> <ul style="list-style-type: none"> <li>(i) Copies of the Supplier's invoice showing Goods' description, quantity, unit price, and total amount;</li> <li>(ii) Delivery note, railway receipt, or truck receipt;</li> <li>(iii) Manufacturer's or Supplier's warranty certificate;</li> <li>(iv) Certificate of origin.</li> </ul> <p>The above documents shall be received by the Purchaser before arrival of the Goods and, if not received, the Supplier will be responsible for any consequent expenses.</p>
GCC 14.2	<p>The prices charged for the Goods supplied and the related Services performed shall not be adjustable.</p>
GCC 15.1	<p>The method and conditions of payment to be made to the Supplier under this Contract shall be as follows:</p> <p>Payment for Goods and Services supplied shall be made in US Dollars, as follows:</p> <ul style="list-style-type: none"> <li>(i) <b>Advance Payment:</b> Ten (10) percent of the Contract Price shall be paid within thirty (30) days of signing of the Contract against a simple receipt and a bank guarantee for the equivalent amount and in the form furnished in <i>Section IX – Contract Forms</i>.</li> <li>(ii) <b>On Acceptance:</b> Eighty (80) percent of the Contract Price of each shipment shall be paid on acceptance of the Goods and upon submission of the documents specified in GCC Clause 12. Payment shall be made in accordance with GCC Clause 15.</li> <li>(iii) <b>On Completion:</b> The remaining ten (10) percent of the Contract Price shall be paid to the Supplier upon the completion of all his obligations under the Contract and the submission of a Defects Liability Security in the value of (10%) of the Contract Price valid for at least (120) days from the date of acceptance of the last shipment. The Defect Liability Security shall be in a form acceptable by the GSD.</li> </ul> <p>Any Single payment shall not be less than US\$ 100,000 in value unless the contract Price is less than this value. If the case is so then the supplier shall submit one payment only.</p>

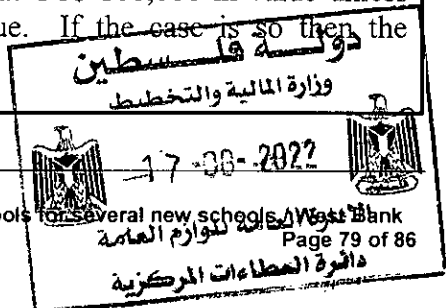



Section IX. Contract Forms

GCC 15.5	<p>The payment-delay period after which the MOE shall pay interest to the supplier shall be (60) days.</p> <p>The interest rate that shall be applied is 0 %</p>
GCC 17.1	<p>A Performance Security shall be required</p> <p>The amount of the Performance Security shall be: 10% of the Contract Price for the period (150 work)</p> <p><b>Maintenance Guarantee for 5% of the Contract value and valid for 1year from the provisional acceptance date.</b></p>
GCC 17.3	<p>The Performance Security shall be in the form of a Bank Guarantee</p> <p>The Performance security shall be denominated in the currency of the Contract.</p> <p>The Performance Security shall be in the form attached in Section IX.</p> <p>The Performance Security shall be valid for the period of executing the Contract.</p>
GCC 22.2	<p>The packing, marking and documentation within and outside the packages shall be (for Imported Goods):</p> <ul style="list-style-type: none"> <li>- All goods parts shall be packed in accordance with good commercial practice, protected from damage during handling and shipping, suitable for tailgate unloading by forklift.</li> <li>- The Supplier shall clearly identify each carton with large stenciling (or other marking visible from a distance) showing Item, Colour, Part Number and School identification number.</li> <li>- Any parts found to be damaged in shipping shall be replaced immediately and at no expense to the MOE</li> <li>- Pallets are to be 1,000 x 1,200 mm GMA 4-way reusable pallets (pallets must be able to withstand multiple moves over rough terrain). Height of loaded pallets shall not exceed 1200 mm</li> </ul>
GCC 23.1	<p>The insurances required from the Supplier shall be an Insurance of Goods whether in transit or stored or delivered and shall not be less than 110% of the Contract Price and shall be on "All Risks" basis, including War Risks and Strikes. (APPLICABLE)</p>
GCC 24.1	<p>Responsibility for transportations shall be as follows: "The Supplier is required under the Contract to transport the Goods to the final destination within the Palestinian Territories (as furnished in the Delivery Schedule).</p>

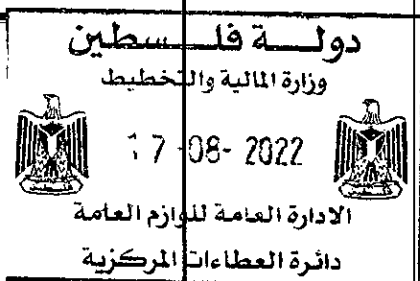

Section IX. Contract Forms

	Transport to such places of destination in the Palestinian Territories, as shall be specified in the Contract including storage, shall be arranged by the Supplier, and related costs shall be included in the Contract Price. The Contractor shall bear all risks relating to the goods until provisional acceptance at destination. The supplies shall be packaged so as to prevent their damage or deterioration in transit to their destination”.
<b>GCC 25.5</b>	The inspections and tests shall be: (ii) All tests necessary to confirm the compliance of the goods and their components with the Technical Specifications. (iii) Tests requested by the MOE upon inspection for acceptance of delivery. These tests might be conducted by the Palestinian Standards Institute (PSI). (iv) Samples to be provided by the Supplier before contract award for inspection by the GSD. The delivery of the samples including cost of manufacturing, transportation back and forth to the GSD, duties, taxes and other levies shall be at the expenses of the Supplier. (v) The costs of testing shall be paid by the Supplier and are considered to be included in the Supplier’s prices.
<b>GCC 25.6</b>	The Inspections and tests shall be conducted at: All places mentioned in the GCC (25.6) and at GSD, Ramallah or any other place identified by the GSD. All Expenses related to inspections and tests shall be included in the prices of the Supplier.  Inspections and tests might be conducted during the production, manufacturing, assembling or preparation processes
<b>GCC 26.1</b>	The liquidated damage shall be: half (0.5) percent of the contract price per week.
<b>GCC 26.1</b>	The maximum amount of liquidated damages shall be: ten (10) percent of the contract price.
<b>GCC 27.3</b>	The period of validity of the Warranty shall be: (365) days from the last acceptance date.  For purposes of the Warranty, the place(s) of final destination(s) shall be as indicated in the Delivery Schedule.  The Warranty shall be in the form of a Judicial Guarantee by the name of the Supplier or by the name of the Local Agent in case of International Supplier for the amount of 115% of the Contract Price.(not applicable)
<b>GCC 27.5</b>	The period for repair or replacement shall be: (15) days.

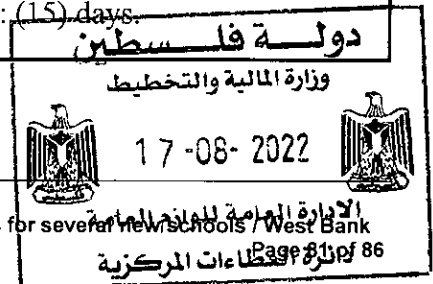

## Section IX. Contract Forms

### Table of Forms

1. Contract Agreement.....	83
----------------------------	----



# 1. Contract Agreement

*[The successful Bidder shall fill in this form in accordance with the instructions indicated]*

THIS CONTRACT AGREEMENT is made

the *[insert: number]* day of *[insert: month]*, *[insert: year]*.

BETWEEN

- (1) *[insert complete name of MOE]*, a *[insert description of type of legal entity, for example, an agency of the Ministry of .... of the Government of {insert name of Country of PD}, or corporation incorporated under the laws of {insert name of Country of PD}]* and having its principal place of business at *[insert address of PD]* (hereinafter called "the PD"), and
- (2) *[insert name of Supplier]*, a corporation incorporated under the laws of *[insert: country of Supplier]* and having its principal place of business at *[insert: address of Supplier]* (hereinafter called "the Supplier").

WHEREAS the PD invited bids for certain Goods and ancillary services, viz., *[insert brief description of Goods and Services]* and has accepted a Bid by the Supplier for the supply of those Goods and Services in the sum of *[insert Contract Price in words and figures, expressed in the Contract currency (ies)]* (hereinafter called "the Contract Price").

NOW THIS AGREEMENT WITNESSETH AS FOLLOWS:

1. In this Agreement words and expressions shall have the same meanings as are respectively assigned to them in the Conditions of Contract referred to.
2. The following documents shall constitute the Contract between the PD and the Supplier, and each shall be read and construed as an integral part of the Contract:
  - (a) This Contract Agreement
  - (b) Special Conditions of Contract
  - (c) General Conditions of Contract
  - (d) Technical Requirements (including Schedule of Requirements and Technical Specifications)
  - (e) The Supplier's Bid and original Price Schedules
  - (f) The PD's Notification of Award
  - (g) *[Add here any other document(s)]*

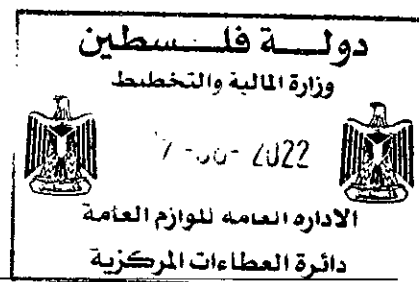

## Section IX. Contract Forms

3. This Contract shall prevail over all other Contract documents. In the event of any discrepancy or inconsistency within the Contract documents, then the documents shall prevail in the order listed above.
4. In consideration of the payments to be made by the MOE to the Supplier as hereinafter mentioned, the Supplier hereby covenants with the MOE to provide the Goods and Services and to remedy defects therein in conformity in all respects with the provisions of the Contract.
5. The MOE hereby covenants to pay the Supplier in consideration of the provision of the Goods and Services and the remedying of defects therein, the Contract Price or such other sum as may become payable under the provisions of the Contract at the times and in the manner prescribed by the Contract.

IN WITNESS whereof the parties hereto have caused this Agreement to be executed in accordance with the laws of *[insert the name of the Contract governing law country]* on the day, month and year indicated above.

For and on behalf of the PD

Signed: *[insert signature]*  
in the capacity of *[insert title or other appropriate designation]*  
in the presence of *[insert identification of official witness]*.

For and on behalf of the Supplier

Signed: *[insert signature of authorized representative(s) of the Supplier]*  
in the capacity of *[insert title or other appropriate designation]*  
in the presence of *[insert identification of official witness]*

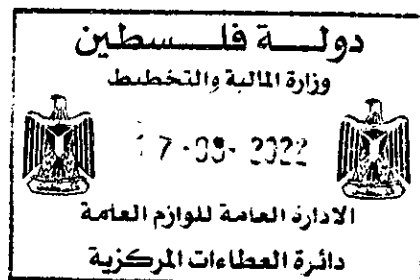

## 2. Performance Security Form

To: Ministry of Education

Date: \_\_\_\_\_

Contract Name:

Contract No.: **MOE/JFA/19.222425/2022/ 171**

Gentlemen and/or Ladies:

Address of guarantor bank:

.....  
 .....

Address of beneficiary (contracting agency):

.....  
 .....

On ..... You concluded with ..... ("Contractor") a contract for  
 Tender for the purchase of equipment and tools for several new schools / West  
 Bank

a price of .....

In accordance with the provisions of the contract, the Contractor is obliged to provide a performance bond for (10 %) ten percent of the contract price. (

We, the undersigned ..... (Guarantor), waiving all objections and defenses under the  
 aforementioned contract, hereby irrevocably and independently guarantee to pay on your first written  
 demand any amount up to a total of ..... (In words:

.....)

Against your written declaration that the Contractor has failed to perform the aforementioned contract.

In the event of any claim under this guarantee, payment shall be effected to the Palestinian Ministry  
 of education Account Number (219000/13) with the Bank of Palestine SWIFT Code PALSPS22.

This guarantee shall expire not later than .....

By this date we must have received any claims by letter, email or encoded telecommunication.

It is understood that you will return this guarantee to us on expiry or after payment of the total amount  
 to be claimed hereunder.

This guarantee is governed by the law of the Palestinian Authority.

Place, date

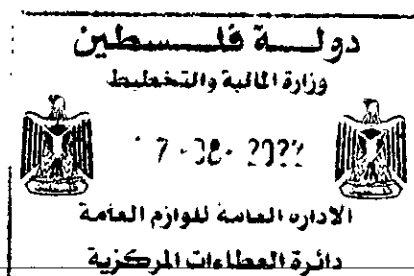

Guarantor

### 3. Standard Form of Advance Payment Bond

Address of guarantor bank:

.....  
 .....  
 .....

Address of Beneficiary (contracting agency):

.....  
 .....  
 .....

On ..... you concluded with ..... ("Contractor") a contract for ..... (project, object of contract) at a price of .....

In accordance with the provisions of the contract the Contractor receives an advance payment in the amount of ....., which represents ..... % of the order value.

We, the undersigned ..... (Guarantor), waiving all objections and defences under the aforementioned contract, hereby irrevocably and independently guarantee to pay on your first written demand any amount advanced to the Contractor up to a total of ..... (in words: .....) against your written declaration that the Contractor has failed to duly perform the aforementioned contract.

This guarantee shall come into force and effect as soon as the advance payment has been credited to the account of the Contractor.

In the event of any claim under this guarantee, payment shall be effected to the Palestinian Ministry of Finance's Account Number (219000/49) with The Bank of Palestine SWIFT Code PALSPS22.

This guarantee shall expire no later than .....

By this date we must have received any claims for payment by letter, email or encoded telecommunication.

It is understood that you will return this guarantee to us on expiry or after payment of the total amount to be claimed hereunder.

This guarantee is governed by the laws of the Palestinian Authority.

Place, date

Guarantor

