



State of Palestine (SP)

Ministry of Finance – Central Tendering Department

For the Benefit of Ministry of Education

**Funded by the
Joint Financing Partners**

Tender Documents for the Procurement of furniture

Tender No: MOE-GSD/ JFA/ 8,13.312235/2022 /136

**Tender Documents for the Procurement of
Manufacture and supply school furniture / West Bank
under the Joint Financing Arrangement**

2022

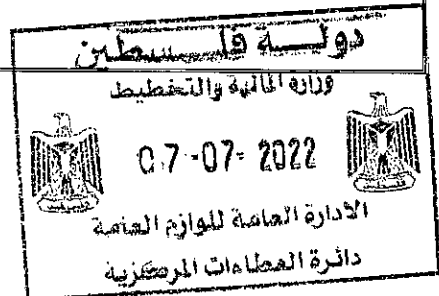

Contents

PART 1 – Bidding Procedures	3
Invitation for Bids (IFB).....	5
Section I. Instructions to Bidders.....	6
Section II. Bidding Data Sheet (BDS).....	27
Section III. Evaluation and Qualification Criteria.....	30
Section IV. Bidding Forms	34
PART 2 – Supply Requirements.....	47
Section VI. Schedule of Requirements	48
Section VIII. Special Conditions of Contract.....	113
Section IX. Contract Forms	118

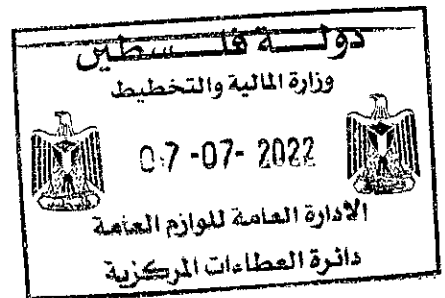

PART 1 – Bidding Procedures



دعوة لتقديم عطاءات

رقم العطاء: MOE-GSD/ JFA.8,13.312235/2022/136
موضوع العطاء: تصنيع وتوريد اثاث مدرسي / الضفة الغربية

1. تلقت وزارة التربية والتعليم منحة مالية بقيمة 35 مليون دولار من دول مانحة وهي ألمانيا وفنلندا وإيرلندا والنرويج فيما يسمى بشركاء التمويل المشترك في إطار تمويل تنفيذ بنود الخطة الاستراتيجية لتطوير التعليم. وعليه تنوي وزارة التربية والتعليم تخصيص جزء من عائدات هذه المنحة لتصنيع وتوريد اثاث مدرسي / الضفة الغربية بموجب العقد وضمن المناقصة رقم: MOE-GSD/ JFA.8,13.312235/2022/136 وسوف يتم تطبيق قيمة المنحة المقدمة من شركات التمويل حصريا لتمويل النفقات.

2. تدعو مديرية اللوازم العامة في وزارة المالية وحساب وزارة التربية والتعليم الجهات المؤهلة لتقديم العطاءات بالظرف المختوم لتوريد المتطلبات لوزارة التربية والتعليم، ومديريات التربية المذكورة في جدول التوزيع المرفق.

3. يمكن للجهات المعنية بالعطاء الحصول على مزيد من المعلومات من مديرية اللوازم العامة في وزارة المالية وجمع وثائق المناقصة من العنوان المذكور في صفحة معلومات العطاء من 8:00 صباحا وحتى 2:00 بعد الظهر.

4. يوجد مجموعة كاملة من وثائق المناقصة باللغة الانجليزية ويمكن شراؤها من قبل مقدمي العطاءات المعنين برسوم غير مستردة وقيمتها (\$ 100) للنسخة الواحدة.

5. تدفع رسوم كراسة المناقصة لحساب وزارة المالية في بنك فلسطين على حساب رقم (219000/49).

يجب أن يتم تسليم العطاءات الى العنوان الموضح أدناه في موعد أقصاه (يوم الثلاثاء 2022/8/16) حيث تقبل الطلبات لغاية الساعة (10:00) صباحا من ذلك التاريخ. ويجب أن ترفق جميع العطاءات بكفالة دخول للعطاء والبالغ 3% من قيمة العرض المقدم وسارية المفعول لغاية 180 يوم من تاريخ آخر موعد لتقديم عروض الأسعار، وسيتم رفض العروض المتأخرة عن الموعد المحدد. سيتم فتح العطاءات بحضور ممثلي مقدمي العطاءات الذين يتم اعتماد طلباتهم في العنوان المذكور في صفحة معلومات العطاء في تمام الساعة 10:00 من صباح يوم الثلاثاء الموافق 2022/8/16.

6. اجور النشر والاعلان على من يرسو عليه العطاء ولمرة واحدة فقط.

7. الاسعار بالدولار وهي غير شاملة لضريبة القيمة المضافة.



مديرية اللوازم العامة
وزارة المالية
مجمع الوزارات، الطابق السادس، المصيون
رام الله (الضفة الغربية)
هاتف: 02-2987112 ، فاكس: 02-2987056

Section I. Instructions to Bidders

Table of Contents



A. General.....	8
1. Scope of Bid.....	8
2. Source of Funds	8
3. Fraud and Corruption	8
4. Eligible Bidders	9
5. Eligible Goods and Related Services	10
B. Contents of Bidding Documents	10
6. Sections of Bidding Documents.....	10
7. Clarification of Bidding Documents.....	11
8. Amendment of Bidding Documents	11
C. Preparation of Bids	11
9. Cost of Bidding	11
10. Language of Bid.....	12
11. Documents Comprising the Bid.....	12
12. Bid Submission Form and Price Schedules	12
13. Alternative Bids	13
14. Bid Prices and Discounts	13
15. Currencies of Bid	13
16. Documents Establishing the Eligibility of the Bidder	13
17. Documents Establishing the Eligibility of the Goods and Related Services	14
18. Documents Establishing the Conformity of the Goods and Related Services.....	14
19. Documents Establishing the Qualifications of the Bidder	14
20. Period of Validity of Bids.....	15
21. Bid Security	15
22. Format and Signing of Bid.....	16
D. Submission and Opening of Bids.....	17
23. Submission, Sealing and Marking of Bids.....	17
24. Deadline for Submission of Bids	17
25. Late Bids	17
26. Withdrawal, Substitution, and Modification of Bids.....	17
27. Bid Opening	18

E. Evaluation and Comparison of Bids	20
28. Confidentiality	20
29. Clarification of Bids.....	20
30. Responsiveness of Bids.....	20
31. Nonconformities, Errors, and Omissions.....	21
32. Preliminary Examination of Bids.....	21
33. Examination of Terms and Conditions; Technical Evaluation	22
34. Conversion to Single Currency	22
35. Domestic Preference	22
36. Evaluation of Bids.....	22
37. Comparison of Bids	23
38. Postqualification of the Bidder	23
39. (GSD)'s Right to Accept Any Bid, and to Reject Any or All Bids	23
F. Award of Contract.....	24
40. Award Criteria	24
41. (GSD)'s Right to Vary Quantities at Time of Award	24
42. Notification of Award	24
43. Signing of Contract	24
44. Performance Security.....	24
45. Reimbursements, Guarantee Or Similar Claimable Payments	25



Section I. Instructions to Bidders

A. General

- 1. Scope of Bid**
- 1.1 The General Supplies Department (GSD) and for the benefit of the MOE issues these Bidding Documents for the supply of Goods and Related Services incidental thereto as specified in Section VI, Schedule of Requirements. The name and identification number of this Bid are **specified in the Bid Data Sheet (BDS)**. The name, identification, and number of lots are **provided in the BDS**.
- 1.2 Throughout these Bidding Documents:
- (a) The term “in writing” means communicated in written form (e.g. by mail, e-mail, fax) with proof of receipt;
- (b) If the context so requires, “singular” means plural and vice versa; and
- (c) “Day” means calendar day.
- 2. Source of Funds**
- 2.1 The Ministry of Education (MOE) has received a grant of \$35M from the Governments of Germany, Finland, Ireland and Norway (**Joint Financing Partners, JFPs**) towards financing the implementation of the Education Development Strategic Plan (EDSP). The MOE intends to apply a portion of the funds to eligible payments under the contract for which these Bidding Documents are issued.
- 3. Fraud and Corruption**
- 3.1 It is a policy to require that (GSD) s as well as bidders, suppliers, and contractors and their subcontractors observe the highest standard of ethics during the procurement and execution of such contracts. In pursuance of this policy, the (GSD):
- (a) defines, for the purposes of this provision, the terms set forth below as follows:
- (i) “corrupt practice” is the offering, giving, receiving or soliciting, directly or indirectly, of anything of value to influence improperly the actions of another party;
- (ii) “fraudulent practice” is any act or omission, including a misrepresentation, that knowingly or recklessly misleads, or attempts to mislead, a party to obtain a financial or other benefit or to avoid an obligation;
- (iii) “collusive practice” is an arrangement between two or more parties designed to achieve an improper purpose,

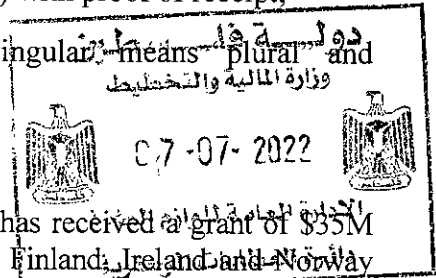

Section I. Instructions to Bidders (ITB)

including to influence improperly the actions of another party;

(iv) “coercive practice” is impairing or harming, or threatening to impair or harm, directly or indirectly, any party or the property of the party to influence improperly the actions of a party;

(v) “obstructive practice” is

(aa) deliberately destroying, falsifying, altering or concealing of evidence material to the investigation or making false statements to investigators in order to materially impede the MOE investigation into allegations of a corrupt, fraudulent, coercive or collusive practice; and/or threatening, harassing or intimidating any party to prevent it from disclosing its knowledge of matters relevant to the investigation or from pursuing the investigation; or

(b) will cancel a proposal for award if it determines that the bidder recommended for award has, directly or through an agent, engaged in corrupt, fraudulent, collusive, coercive or obstructive practices in competing for the contract in question;

(c) will sanction a firm or individual, including declaring ineligible, either indefinitely or for a stated period of time, to be awarded a contract if it at any time determines that the firm has, directly or through an agent, engaged in corrupt, fraudulent, collusive, coercive or obstructive practices in competing for, or in executing, a contract; and

3.2 Furthermore, Bidders shall be aware of the provision stated in Sub-Clause 34.1 (a) (iii) of the General Conditions of Contract.

4. Eligible Bidders

4.1 Participation in the bidding procedure is open to all interested Bidders except:

a. For those Bidders ruled out by the Security Council.

b. If the Palestinian Authority prohibits commercial relations with the manufacturing entities or with their Countries.

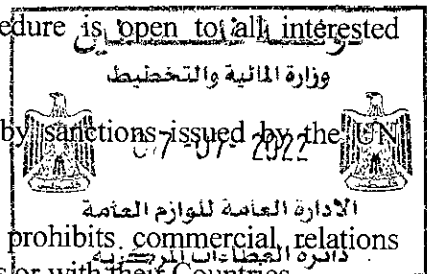

4.2 A Bidder shall not have a conflict of interest. All bidders found to have conflict of interest shall be disqualified. Bidders may be considered to have a conflict of interest with one or more parties in this bidding process, if they:

Section I. Instructions to Bidders (ITB)

- (a) are or have been associated in the past, with a firm or any of its affiliates which have been engaged by the MOE to provide consulting services for the preparation of the design, specifications, and other documents to be used for the procurement of the goods to be purchased under these Bidding Documents ; or
- (b) Submit more than one bid in this bidding process.
- 4.3 Bidders shall provide such evidence of their continued eligibility satisfactory to the (GSD), as the The (GSD) shall reasonably request.
- 5. Eligible Goods and Related Services**
- 5.1 All the Goods and Related Services to be supplied under the Contract may have their origin in any country except:
- (a) As a matter of law or official regulation, the Palestinian Authority prohibits commercial relations with that Country or with the manufacturing entities.
- (b) by an Act of Compliance with a Decision of the United Nations Security Council taken under Chapter VII of the Charter of the United Nations, the Palestinian Authority prohibits any import of goods from that Country or any payments to persons or entities in that Country.

B. Contents of Bidding Documents

- 6. Sections of Bidding Documents**
- 6.1 The Bidding Documents consist of Parts 1, 2, and 3, which include all the Sections indicated below, and should be read in conjunction with any Addendum issued in accordance with ITB Clause 8.

PART 1 Bidding Procedures

- Section I. Instructions to Bidders (ITB)
- Section II. Bidding Data Sheet (BDS)
- Section III. Evaluation and Qualification Criteria
- Section IV. Bidding Forms
- Section V. Eligible Countries



PART 2 Supply Requirements

- Section VI. Schedule of Requirements

PART 3 Contract

- Section VII. General Conditions of Contract (GCC)
- Section VIII. Special Conditions of Contract (SCC)
- Section IX. Contract Forms

6.2 The Bidder is expected to examine all instructions, forms, terms, and specifications in the Bidding Documents. Failure to furnish all information or documentation required by the Bidding Documents may result in the rejection of the bid.

7. Clarification of Bidding Documents

7.1 A prospective Bidder requiring any clarification of the Bidding Documents shall contact the (GSD) in writing at the (GSD)'s address **specified in the BDS**. The (GSD) will respond in writing to any request for clarification, provided that such request is received no later than ten (10) days prior to the deadline for submission of bids. The (GSD) shall forward copies of its response to all those who have acquired the Bidding Documents directly from it, including a description of the inquiry but without identifying its source.

7.2 Should the (GSD) deem it necessary to amend the Bidding Documents as a result of a clarification, it shall do so following the procedure under ITB Clause 8 and ITB Sub-Clause 24.3.

8. Amendment of Bidding Documents

8.1 At any time prior to the deadline for submission of bids, the (GSD) may amend the Bidding Documents by issuing addendum.

8.2 Any addendum issued shall be part of the Bidding Documents and shall be communicated in writing to all who have obtained the Bidding Documents directly from the (GSD).

8.3 To give prospective Bidders reasonable time in which to take an addendum into account in preparing their bids, the (GSD) may, at its discretion, extend the deadline for the submission of bids, pursuant to ITB Sub-Clause 24.3.

C. Preparation of Bids

9. Cost of Bidding

9.1 The Bidder shall bear all costs associated with the preparation and submission of its bid, and the (GSD) shall not be responsible or liable for those costs, regardless of the conduct or outcome of

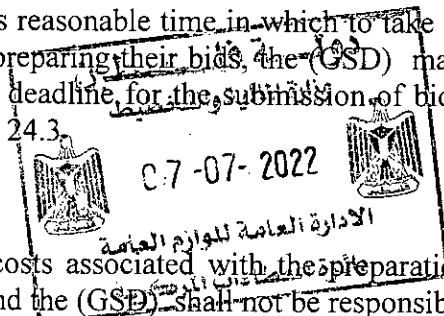

the bidding process.

10. Language of Bid

10.1 The Bid, as well as all correspondence and documents relating to the bid exchanged by the Bidder and the The (GSD), shall be written in the language **specified in the BDS**. Supporting documents and printed literature that are part of the Bid may be in another language provided they are accompanied by an accurate translation of the relevant passages into the language **specified in the BDS**, in which case, for purposes of interpretation of the Bid, such translation shall govern.

11. Documents Comprising the Bid

11.1 The Bid shall comprise the following:

- (a) Dully signed Declaration of Undertaking furnished in Section IV.
- (b) Bid Submission Form and the applicable Price Schedules, in accordance with ITB Clauses 12, 14, and 15;
- (c) Bid Security in accordance with ITB Clause 21, if required;
- (d) written confirmation authorizing the signatory of the Bid to commit the Bidder, in accordance with ITB Clause 22;
- (e) documentary evidence in accordance with ITB Clause 16 establishing the Bidder's eligibility to bid;
- (f) documentary evidence in accordance with ITB Clause 17, that the Goods and Related Services to be supplied by the Bidder are of eligible origin;
- (g) documentary evidence in accordance with ITB Clauses 18 and 30, that the Goods and Related Services conform to the Bidding Documents;
- (h) documentary evidence in accordance with ITB Clause 19 establishing the Bidder's qualifications to perform the contract if its bid is accepted; and
- (i) any other document **required in the BDS. 07-07-2022**

12. Bid Submission Form and Price Schedules

12.1 The Bidder shall submit the Bid Submission Form using the form furnished in Section IV, Bidding Forms. This form must be completed without any alterations to its format, and no substitutes shall be accepted. All blank spaces shall be filled in with the information requested.

12.2 The Bidder shall submit the Price Schedules for Goods and Related Services, according to their origin as appropriate, using

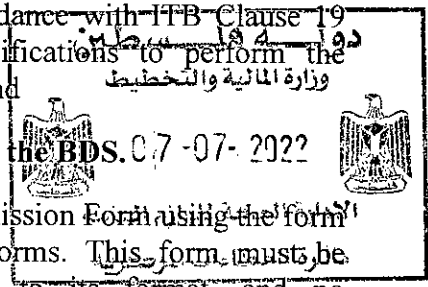

Section I. Instructions to Bidders (ITB)

the forms furnished in Section IV, Bidding Forms

13. Alternative Bids 13.1 Unless otherwise **specified in the BDS**, alternative bids shall not be considered.

14. Bid Prices and Discounts 14.1 The prices and discounts quoted by the Bidder in the Bid Submission Form and in the Price Schedules shall conform to the requirements specified below.

14.2 All lots items must be listed and priced separately in the Price Schedules.

14.3 The price to be quoted in the Bid Submission Form shall be the total price of the bid, excluding any discounts offered.

14.4 The Bidder shall quote any unconditional discounts in the Bid Submission Form and in the Price Schedule Form.

14.5 Unless stated otherwise in the bidding documents, the Contract shall be based on the unit rates and prices in the Bills of Quantities submitted by the bidder.

14.6 All duties, taxes, and other levies payable by the Supplier under the Contract, or for any other cause, as of the date for submission of bids with the exception of Value Added Tax (VAT), shall be included in the rates and prices and the total Bid Price submitted by the bidder. The bid rates and prices shall also include all associated costs to be borne by the Supplier including all overheads and profits.

14.7 Prices quoted by the Bidder shall be fixed during the Bidder's performance of the Contract and not subject to variation on any account. A Bid submitted with an adjustable price quotation shall be treated as non responsive and shall be rejected.

14.8 Bids are being invited for individual contracts (lots) or for any combination of contracts (packages). Prices quoted shall correspond to 100 % of the items specified for each lot and to 100% of the quantities specified for each item of a lot.

15. Currencies of Bid 15.1 The Bidder shall quote in the currency specified in the **BDS**.

16. Documents Establishing the Eligibility of the Bidder 16.1 To establish their eligibility in accordance with ~~ITB~~ Clause 4, Bidders shall complete the Bid Submission Form, included in Section IV, Bidding Forms.

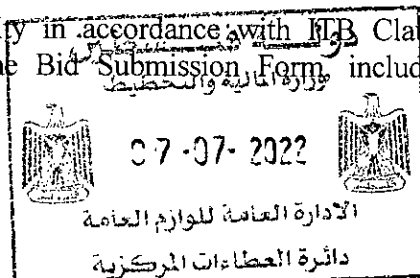

Section I. Instructions to Bidders (ITB)

17. Documents
Establishing the Eligibility of the Goods and Related Services
- 17.1 To establish the eligibility of the Goods and Related Services in accordance with ITB Clause 5, Bidders shall complete the country of origin declarations in the Price Schedule Forms included in Section IV, Bidding Forms.
18. Documents
Establishing the Conformity of the Goods and Related Services
- 18.1 To establish the conformity of the Goods and Related Services to the Bidding Documents, the Bidder shall furnish as part of the Bid the documentary evidence that the Goods conform to the technical specifications and standards specified in Section VI, Schedule of Requirements.
- 18.2 The documentary evidence may be in the form of literature, drawings or data, and shall consist of a detailed item by item description of the essential technical and performance characteristics of the Goods and Related Services, demonstrating substantial responsiveness of the Goods and Related Services to the technical specification, and if applicable, a statement of deviations and exceptions to the provisions of the Schedule of Requirements.
- 18.3 Standards for workmanship, process, material, and equipment, as well as references to brand names or catalogue numbers specified in the Schedule of Requirements, are intended to be descriptive only and not restrictive. The Bidder may offer other standards of quality, brand names, and/or catalogue numbers, provided that it demonstrates, to the MOE's satisfaction, that the substitutions ensure substantial equivalence or are superior to those specified in the Schedule of Requirements.
19. Documents
Establishing the Qualifications of the Bidder
- 19.1 The documentary evidence of the Bidder's qualifications to perform the contract if its bid is accepted shall establish to the (GSD)'s satisfaction:
- (a) that, if **required in the BDS**, a Bidder that does not manufacture or produce the Goods it offers to supply shall submit the Manufacturer's Authorization using the form included in Section IV, Bidding Forms to demonstrate that it has been duly authorized by the manufacturer or producer of the Goods to supply these Goods in the Palestinian Territories;
- (b) that, in case of a Bidder not doing business within the Palestinian Territories, the Bidder is or will be (if awarded the contract) represented by an Agent in the State of Palestine equipped and able to carry out the Supplier's maintenance, repair and spare parts-stocking obligations

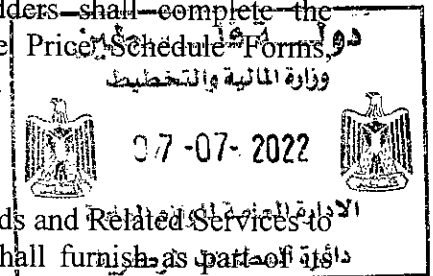

Section I. Instructions to Bidders (ITB)

prescribed in the Conditions of Contract and/or Technical Specifications; and

- (c) that the Bidder meets each of the qualification criterion specified in Section III, Evaluation and Qualification Criteria.

20. Period of Validity of Bids

- 20.1 Bids shall remain valid for the period **specified in the BDS** after the bid submission deadline date prescribed by the GSD. A bid valid for a shorter period shall be rejected by the GSD as non responsive.
- 20.2 In exceptional circumstances, prior to the expiration of the bid validity period, the GSD may request bidders to extend the period of validity of their bids. The request and the responses shall be made in writing. If a Bid Security is requested in accordance with ITB Clause 21, it shall also be extended for a corresponding period. A Bidder may refuse the request without forfeiting its Bid Security. A Bidder granting the request shall not be required or permitted to modify its bid.

21. Bid Security

- 21.1 The Bidder shall furnish as part of its bid, a Bid Security as **specified in the BDS**.
- 21.2 The Bid Security shall be in the amount specified in the BDS and denominated in the currency of the Bid and shall:
- (a) be issued by a reputable institution selected by the bidder and located in any eligible country. If the institution issuing the Bid Security is located outside the Palestinian Territories, it shall have a correspondent financial institution located in the State of Palestine to make it enforceable. The Bid Security shall comply with the rules of the Palestinian Monetary Authority.
 - (b) be strictly in accordance with the form of Bid Security included in Section IV, Bidding Forms.
 - (c) be payable promptly upon written demand by the MOE;
 - (d) be submitted in its original form; copies will not be accepted;
 - (e) remain valid for a period of 28 days beyond the validity period of the bids, as extended, if applicable, in accordance with ITB Clause 20.2;

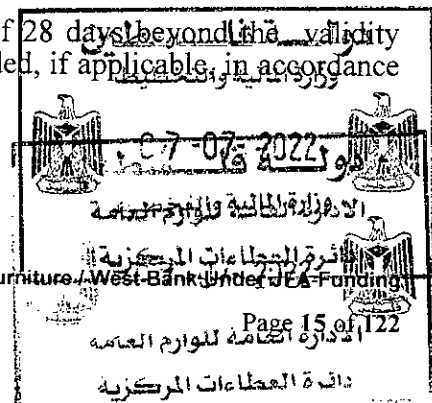

Section I. Instructions to Bidders (ITB)

- 21.3 Any bid not accompanied by a substantially responsive Bid Security shall be rejected by the GSD as non-responsive.
- 21.4 The Bid Security of unsuccessful Bidders shall be returned as promptly as possible upon the successful Bidder's furnishing of the Performance Security pursuant to ITB Clause 44.
- 21.5 The Bid Security may be forfeited or the Bid Securing Declaration executed:
- (a) if a Bidder withdraws its bid during the period of bid validity specified in the Bidding Documents; or
 - (b) if the successful Bidder fails to:
 - (i) sign the Contract in accordance with ITB Clause 43;
 - (ii) furnish a Performance Security in accordance with ITB Clause 44.

22. Format and Signing of Bid

- 22.1 The Bidder shall prepare one original of the documents comprising the bid as described in ITB Clause 11 and clearly mark it "ORIGINAL." In addition, the Bidder shall submit copies of the bid, in the number specified in the **BDS** and clearly mark them "COPY." In the event of any discrepancy between the original and the copies, the original shall prevail.
- 22.2 The original and all copies of the bid shall be typed or written in indelible ink and shall be signed by a person duly authorized to sign on behalf of the Bidder.
- 22.3 Any interlineation, erasures, or overwriting shall be valid only if they are signed or initialed by the person signing the Bid.

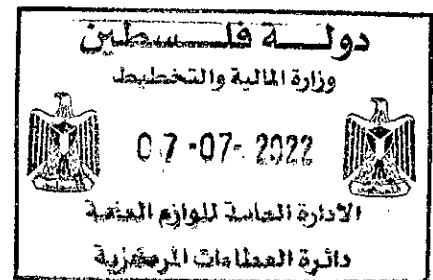

D. Submission and Opening of Bids

23. Submission, Sealing and Marking of Bids

23.1 Bidders may submit their bids by mail or by hand (submission by E-mail is not allowed). Bidders submitting bids by mail or by hand, shall enclose the original and each copy of the Bid in separate sealed envelopes, duly marking the envelopes as "ORIGINAL" and "COPY." These envelopes containing the original and the copies shall then be enclosed in one single envelope.

23.2 The inner and outer envelopes shall:

- (a) Bear the name and address of the Bidder;
- (b) be addressed to the GSD in accordance with ITB Sub-Clause 24.1;
- (c) bear the specific identification of this bidding process indicated in ITB 1.1 and any additional identification marks as **specified in the BDS**; and
- (d) bear a warning not to open before the time and date for bid opening, in accordance with ITB Sub-Clause 27.1.

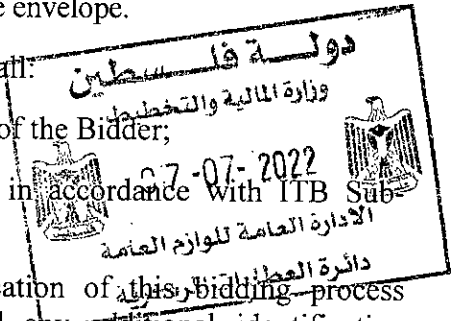

23.3 If all envelopes are not sealed and marked as required, the GSD will assume no responsibility for the misplacement or premature opening of the bid.

24. Deadline for Submission of Bids

24.1 Bids must be received by the GSD at the address and no later than the date and time **specified in the BDS**.

24.2 If the Bidder choose to submit its bid by mail (submission by E-mail shall not be permitted), the GSD shall not bear any responsibility for any delay in submission.

24.3 The GSD may, at its discretion, extend the deadline for the submission of bids by amending the Bidding Documents in accordance with ITB Clause 8, in which case all rights and obligations of the GSD and Bidders previously subject to the deadline shall thereafter be subject to the deadline as extended.

25. Late Bids

25.1 The GSD shall not consider any bid that arrives after the deadline for submission of bids, in accordance with ITB Clause 24. Any bid received by the GSD after the deadline for submission of bids shall be declared late, rejected, and returned unopened to the Bidder.

26. Withdrawal, Substitution, and

26.1 A Bidder may withdraw, substitute, or modify its Bid after it has been submitted by sending a written notice in accordance with ITB Clause 23, duly signed by an authorized representative, and shall include a copy of the authorization (the power of attorney)

Modification of Bids

in accordance with ITB Sub-Clause 22.2, (except that no copies of the withdrawal notice are required). The corresponding substitution or modification of the bid must accompany the respective written notice. All notices must be:

- (a) submitted in accordance with ITB Clauses 22 and 23 (except that withdrawal notices do not require copies), and in addition, the respective envelopes shall be clearly marked "WITHDRAWAL," "SUBSTITUTION," or "MODIFICATION;" and
- (b) received by the GSD prior to the deadline prescribed for submission of bids, in accordance with ITB Clause 24.

26.2 Bids requested to be withdrawn in accordance with ITB Sub-Clause 26.1 shall be returned unopened to the Bidders.

26.3 No bid may be withdrawn, substituted, or modified in the interval between the deadline for submission of bids and the expiration of the period of bid validity specified in the BDS or any extension thereof.

27. Bid Opening

27.1 The GSD shall conduct the bid opening in public at the address, date and time **specified in the BDS.**

27.2 First, envelopes marked "WITHDRAWAL" shall be opened and read out and the envelope with the corresponding bid shall not be opened, but returned to the Bidder. If the withdrawal envelope does not contain a copy of the "power of attorney" confirming the signature as a person duly authorized to sign on behalf of the Bidder, the corresponding bid will be opened. No bid withdrawal shall be permitted unless the corresponding withdrawal notice contains a valid authorization to request the withdrawal and is read out at bid opening. Next, envelopes marked "SUBSTITUTION" shall be opened and read out and exchanged with the corresponding Bid being substituted, and the substituted Bid shall not be opened, but returned to the Bidder. No Bid substitution shall be permitted unless the corresponding substitution notice contains a valid authorization to request the substitution and is read out at bid opening. Envelopes marked "MODIFICATION" shall be opened and read out with the corresponding Bid. No Bid modification shall be permitted unless the corresponding modification notice contains a valid authorization to request the modification and is read out at Bid opening. Only envelopes that are opened and read out at Bid opening shall be considered further.

27.3 All other envelopes shall be opened one at a time, reading out: the name of the Bidder and whether there is a modification; the Bid Prices, including any discounts and alternative offers; the

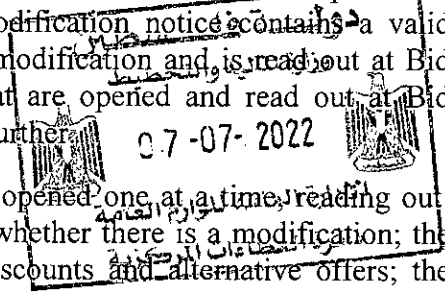

Section I. Instructions to Bidders (ITB)

presence of a Bid Security and any other details as the GSD may consider appropriate. Only discounts and alternative offers read out at Bid opening shall be considered for evaluation. No Bid shall be rejected at Bid opening except for late bids, in accordance with ITB Sub-Clause 25.1.

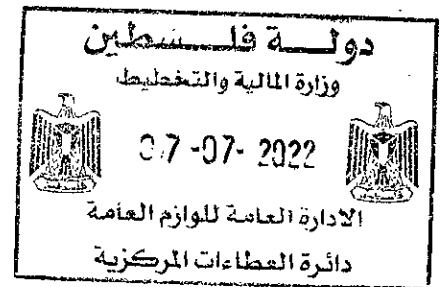

E. Evaluation and Comparison of Bids

- 28. Confidentiality**
- 28.1 Information relating to the examination, evaluation, comparison, and post-qualification of bids, and recommendation of contract award, shall not be disclosed to bidders or any other persons not officially concerned with such process until publication of the Contract Award.
- 28.2 Any effort by a Bidder to influence the GSD in the examination, evaluation, comparison, and post qualification of the bids or contract award decisions may result in the rejection of its Bid.
- 28.3 Notwithstanding ITB Sub-Clause 28.2, from the time of bid opening to the time of Contract Award, if any Bidder wishes to contact the GSD on any matter related to the bidding process, it should do so in writing.
- 29. Clarification of Bids**
- 29.1 To assist in the examination, evaluation, comparison and post-qualification of the bids, the GSD may, at its discretion, ask any Bidder for a clarification of its Bid. Any clarification submitted by a Bidder in respect to its Bid and that is not in response to a request by the GSD shall not be considered. The GSD's request for clarification and the response shall be in writing. No change in the prices or substance of the Bid shall be sought, offered, or permitted, except to confirm the correction of arithmetic errors discovered by the GSD in the Evaluation of the bids in accordance with ITB Clause 31.
- 30. Responsiveness of Bids**
- 30.1 The GSD's determination of a bid's responsiveness is based on the contents of the bid itself.
- 30.2 A substantially responsive Bid is one that conforms to all the terms, conditions, and specifications of the Bidding Documents without material deviation, reservation, or omission. A material deviation, reservation, or omission is one that:
- affects in any substantial way the scope, quality, or performance of the Goods and Related Services specified in the Contract; or
 - limits in any substantial way, inconsistent with the Bidding Documents, the GSD's rights or the Bidder's obligations under the Contract; or
 - if rectified would unfairly affect the competitive position of other bidders presenting substantially responsive bids.
- 30.3 If a bid is not substantially responsive to the Bidding Documents, it shall be rejected by the GSD and may not subsequently be

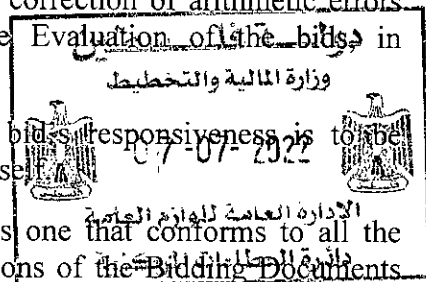

made responsive by the Bidder by correction of the material deviation, reservation, or omission.

31. Nonconformities, Errors, and Omissions

- 31.1 Provided that a Bid is substantially responsive, the GSD may waive any non-conformities or omissions in the Bid that do not constitute a material deviation.
- 31.2 Provided that a bid is substantially responsive, the GSD may request that the Bidder submit the necessary information or documentation, within a reasonable period of time, to rectify nonmaterial nonconformities or omissions in the bid related to documentation requirements. Such omission shall not be related to any aspect of the price of the Bid. Failure of the Bidder to comply with the request may result in the rejection of its Bid.
- 31.3 Provided that the Bid is substantially responsive, the GSD shall correct arithmetical errors on the following basis:
- (a) if there is a discrepancy between the unit price and the line item total that is obtained by multiplying the unit price by the quantity, the unit price shall prevail and the line item total shall be corrected, unless in the opinion of the GSD there is an obvious misplacement of the decimal point in the unit price, in which case the line item total as quoted shall govern and the unit price shall be corrected;
 - (b) if there is an error in a total corresponding to the addition or subtraction of subtotals, the subtotals shall prevail and the total shall be corrected; and
 - (c) if there is a discrepancy between words and figures, the amount in words shall prevail, unless the amount expressed in words is related to an arithmetic error, in which case the amount in figures shall prevail subject to (a) and (b) above.
- 31.4 If the Bidder that awarded the Bid or part of the Bid does not accept the correction of errors, its Bid shall be rejected and its Bid Security shall be forfeited proportionally.

32. Preliminary Examination of Bids

- 32.1 The GSD shall examine the bids to confirm that all documents and technical documentation requested in ITB Clause 11 have been provided, and to determine the completeness of each document submitted.
- 32.2 The GSD shall confirm that the following documents and information have been provided in the Bid. If any of these documents or information is missing, the offer shall be rejected.
- (a) Bid Submission Form, in accordance with ITB Sub-Clause 12.1;

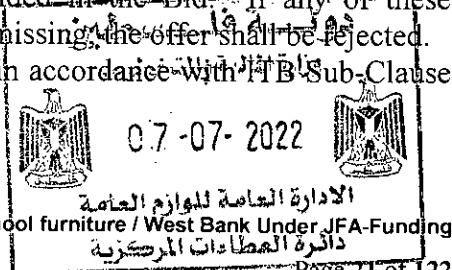

Section I. Instructions to Bidders (ITB)

- (b) Price Schedules, in accordance with ITB Sub-Clause 12.2;
- (c) Bid Security, in accordance with ITB Clause 21.
- (d) The duly signed Declaration of Undertaking attached in Section IV "Bidding Forms"
- 33. Examination of Terms and Conditions; Technical Evaluation**
- 33.1 The GSD shall examine the Bid to confirm that all terms and conditions specified in the GCC and the SCC have been accepted by the Bidder without any material deviation or reservation.
- 33.2 The GSD shall evaluate the technical aspects of the Bid submitted in accordance with ITB Clause 18, to confirm that all requirements specified in Section VI, Schedule of Requirements of the Bidding Documents have been met without any material deviation or reservation.
- 33.3 If, after the examination of the terms and conditions and the technical evaluation, the GSD determines that the Bid is not substantially responsive in accordance with ITB Clause 30, it shall reject the Bid.
- 34. Conversion to Single Currency**
- 34.1 For evaluation and comparison purposes, the GSD shall convert all bid prices expressed in amounts in various currencies into an amount in a single currency **specified in the BDS**, using the selling exchange rates established by the source and on the date **specified in the BDS**.
- 35. Domestic Preference**
- 35.1 Domestic preference shall not be a factor in bid evaluation.
- 36. Evaluation of Bids**
- 36.1 The GSD shall evaluate each bid that has been determined, up to this stage of the evaluation, to be substantially responsive.
- 36.2 To evaluate a Bid, the GSD shall only use all the factors, methodologies and criteria defined in ITB Clause 36. No other criteria or methodology shall be permitted.
- 36.3 To evaluate a Bid, the GSD shall consider the following:
- (a) evaluation will be done for Lots, as **specified in the BDS**; and the Bid Price as quoted in accordance with clause 14;
- (b) price adjustment for correction of arithmetic errors in accordance with ITB Sub-Clause 31.3;
- (c) price adjustment due to discounts offered in accordance with ITB Sub-Clause 14.4;
- 36.4 In order to verify quality of product for final award decision it is

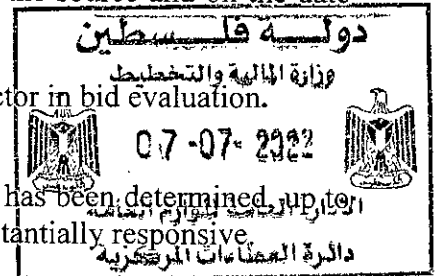

Section I. Instructions to Bidders (ITB)

required to provide original samples at a later stage and prior to the award of the Contract.

- a. Samples of items shall be delivered to the GSD in Ramallah no later than ten (10) days of the GSD request.
- b. Samples will be inspected and comments on defects will be submitted to Bidders for remedy.
- c. Corrected samples shall be redelivered within ten (10) days from the receipt of the comments by the Bidder for final inspection.
- d. Under no circumstances claims for transport from and back to the Supplier will be accepted by the Employer.

37. Comparison of Bids

37.1 The GSD shall compare all substantially responsive bids.

38. Postqualification of the Bidder

38.1 The GSD shall determine to its satisfaction whether the Bidder that is selected as having submitted the lowest evaluated and substantially responsive bid is qualified to perform the Contract satisfactorily.

38.2 The determination shall be based upon an examination of the documentary evidence of the Bidder's qualifications submitted by the Bidder, pursuant to ITB Clause 19.

38.3 An affirmative determination shall be a prerequisite for award of the Contract to the Bidder. A negative determination shall result in disqualification of the bid, in which event the GSD shall proceed to the next lowest evaluated bid to make a similar determination of that Bidder's capabilities to perform satisfactorily.

39. GSD's Right to Accept Any Bid, and to Reject Any or All Bids

39.1 The GSD reserves the right to accept or reject any bid, and to annul the bidding process and reject all bids at any time prior to contract award, without thereby incurring any liability to Bidders.

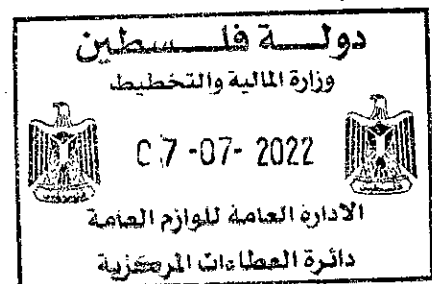

F. Award of Contract

- 40. Award Criteria** 40.1 For each Lot, the GSD shall award the Contract to the Bidder whose offer has been determined to be the lowest evaluated bid for that Lot and is substantially responsive to the Bidding Documents, provided further that the Bidder is determined to be qualified to perform the Contract satisfactorily.
- 41. GSD's Right to Vary Quantities at Time of Award** 41.1 At the time the Contract is awarded, the GSD reserves the right to increase or decrease the quantity of Goods and Related Services originally specified in Section VI, Schedule of Requirements, provided this does not exceed the percentages **specified in the BDS**, and without any change in the unit prices or other terms and conditions of the bid and the Bidding Documents.
- 42. Notification of Award** 42.1 Prior to the expiration of the period of bid validity, the GSD shall notify the successful Bidder, in writing, that its Bid has been accepted.
- 42.2 Until a formal Contract is prepared and executed, the notification of award shall constitute a binding Contract.
- 42.3 Upon the successful Bidder's furnishing of the signed Contract Form and performance security pursuant to ITB Clause 44, the GSD will promptly notify each unsuccessful Bidder and will discharge its bid security, pursuant to ITB Clause 21.4.
- 43. Signing of Contract** 43.1 Within fourteen (14) days of receipt of the notification of award from the GSD, the successful Bidder(s) shall come to the GSD offices in Ramallah to sign the Contract Agreement.
- 44. Performance Security** 44.1 Within fourteen (14) days of the receipt of notification of award from the GSD, the successful Bidder shall furnish the Performance Security in accordance with the GCC, using for that purpose the Performance Security Form included in Section IX Contract forms. The GSD shall promptly notify the name of the winning Bidder(s) to each unsuccessful Bidder and discharge the Bid Securities of the unsuccessful bidders pursuant to ITB Sub-Clause 21.4.
- 44.2 Failure of the successful Bidder(s) to submit the above-mentioned Performance Security or sign the Contract shall constitute sufficient grounds for the annulment of the award and forfeiture of the Bid Security. In that event the GSD may award the Contract to the next lowest evaluated Bidder, whose offer is substantially responsive and is determined by the GSD to be

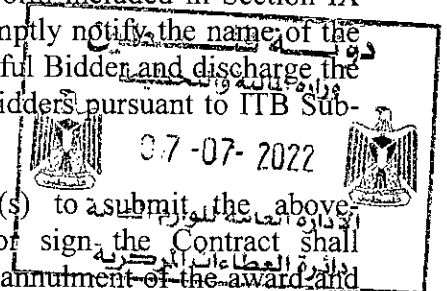

Section I. Instructions to Bidders (ITB)

qualified to perform the Contract satisfactorily.

- 45. Reimbursements, Guarantee Or Similar Claimable Payments** 45.1 Any reimbursements, guarantee or similar claimable payments and any insurance payments shall be made to the Palestinian Ministry of Finance's Account Number (219000/49) in the Bank of Palestine, SWIFT Code PALSPS22.

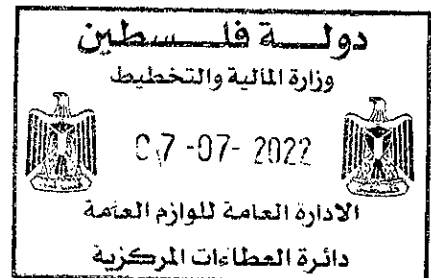

Section II. Bidding Data Sheet (BDS)

The following specific data for the goods to be procured shall complement, supplement, or amend the provisions in the Instructions to Bidders (ITB). Whenever there is a conflict, the provisions herein shall prevail over those in ITB.

A. General	
ITB 1.1	The name and identification number of the Tender : [supply of Furniture, tender number MOE-GSD/ JFA.8,13.312235/2022/136] The number, identification and names of the lots comprising this Bid are: [Manufacture and supply of school furniture / West Bank]
ITB 2.1	The name of the Project is: [JFA]
B. Contents of Bidding Documents	
ITB 7.1	For Clarification of bid purposes only, the Directorate of General Supplies' address is: Attention: Director General of Supplies Directorate of General Supplies. Ministry of Finance Al-Quds Building, 6rd Floor, Al-Masyoon Ramallah, West Bank. Tel. ++97022987112 Fax. ++97022987056
C. Preparation of Bids	
ITB 10.1	The language of the bid is "English"
ITB 11.1 (h)	The Bidder shall submit the following additional documents in its bid: No additional documents are required.
ITB 13.1	Alternative Bids shall not be considered.
ITB 14.7	The prices quoted by the Bidder shall not be adjustable.
ITB 14.8	Prices quoted for each lot shall correspond at least to 100% of the items specified for each lot. Prices quoted for each item shall correspond at least to 100 percent of the quantities specified for this item of a lot.
ITB 15.1	The Bidder is required to quote in US Dollars.

Section II. Bidding Data Sheet

ITB 19.1 (a)	Manufacturer's authorization is required
ITB 19.1 (b)	After sales service is: <i>required</i>
ITB 20.1	The bid validity period shall be 150 days.
ITB 21.1	Bid shall include a Bid Security issued by a bank in the form included in Section IV Bidding Forms and comply with the conditions of ITB 21.
ITB 21.2	The amount of the Bid Security shall be <i>3% of the bidder total bid and valid for 180 days</i> from bid submission date
ITB 22.1	In addition to the original of the bid, the number of copies is: (1)
D. Submission and Opening of Bids	
ITB 23.2 (c)	The inner and outer envelopes shall bear the following additional identification marks: supply of Furniture, <i>tender number</i> MOE-GSD/ JFA.8,13.312235/2022 /136]
ITB 24.1	For bid submission purposes the address is: Directorate of General Supplies Ministry of Finance Al-Quds Building, 6rd Floor, Al-Masyoon Ramallah, West Bank Tel. ++97022987112 Fax. ++97022987056 The deadline for the submission of bids is: Date: 16, August 2022 Time: 10:00 a.m.
ITB 27.1	The bid opening shall take place at: Directorate of General Supplies Ministry of Finance Al-Quds Building, 6rd Floor, Al-Masyoon Ramallah, West Bank Tel. ++97022987112 Fax. ++97022987056 Date: 16, August 2022 Time: 10:00 a.m.
E. Evaluation and Comparison of Bids	

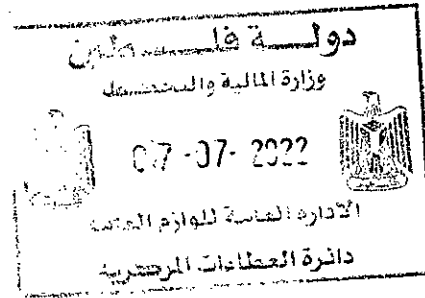

Section II. Bidding Data Sheet

ITB 34.1	Bid prices expressed in different currencies shall be converted in: Not Applicable.
ITB 36.3(a)	Bids will be evaluated GROUP BASIS If a Price Schedule shows items listed but not priced or item not listed in the Price Schedule then the Bidder will be disqualified.
ITB 36.3(d)	The adjustments shall be determined using the following criteria, from amongst those set out in Section III, Evaluation and Qualification Criteria: (a) Deviation in Delivery schedule: <i>No.</i> (b) Deviation in payment schedule: <i>No.</i>
ITB 36.6	Bidders <i>shall</i> be allowed to quote separate prices for one or more groups.
F. Award of Contract	
ITB 41.1	The maximum percentage by which quantities may be increased is: 25% The maximum percentage by which quantities may be decreased is: 25%



Section III. Evaluation and Qualification Criteria

Contents

1. Post-qualification Requirements (ITB 38.2)

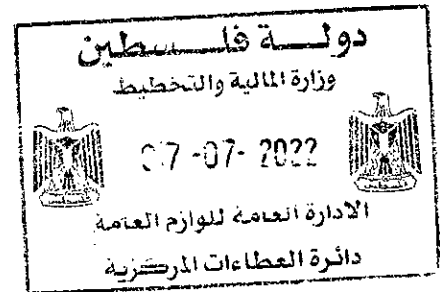

1. Post-qualification Requirements (ITB 38.2)

The GSD will carry out the post-qualification of the Bidder in accordance with ITB Clause 38, using only the requirements specified. For any Bidder to pass the post-qualification, he shall satisfy all the requirements listed below. If any of the listed requirements is not fulfilled the Bidder will be considered as unsuccessful and he will not be financially evaluated:

a. Local Bidders:

- The Bidder shall be legally registered with the Ministry of National Economy of the Palestinian Authority.
- The Bidder shall be registered for the purpose of taxation with the Ministry of Finance of the Palestinian Authority.
- The Bidder shall submit an approved financial report approved by an authorized legal auditor for the last three years evidencing the generation of profit. If the business life is less than three years, then the report shall cover the business life.
- The Bidder shall have locally the following technical capacity requirements:

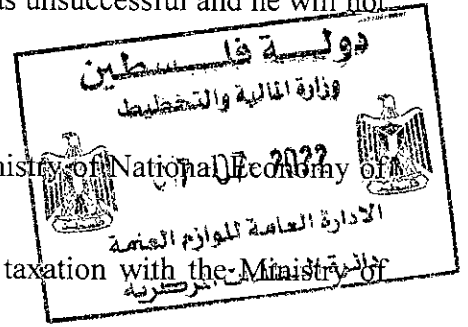

Item	Requirement
Automatic Thermal Painting Furnace	One Unit
Cutting Machines	Minimum Two
Bending Machines	Minimum Two
CO2 Welding Machine	Minimum Four
Storage Area	Minimum 400 m ²

Note: If the bidder does not have a painting furnace, he shall indicate the place where the painting shall take place. The place shall be inspected by the GSD to ensure the availability of the furnace.

b. International Bidders:

1. The Bidder shall have a legal address in the Palestinian Territories.
2. The Bidder shall be registered for purposes of taxation with the Ministry of Finance of the Palestinian Authority.
3. The Bidder shall have a legally registered Local Agent (The local agent shall not participate in the bid independently. If so happen both the International Bidder and the Local Agent will be disqualified).

4. Financial Capability

The Bidder shall furnish documentary evidence that it meets the following financial requirement(s):

- The Bidder shall submit an approved financial report for the last three years evidencing the generation of profit.
- Annual average turnover for the last five years not less than TWICE the value of his bid.

5. Experience and Technical Capacity

The Bidder shall furnish documentary evidence to demonstrate that it meets the following experience requirement(s):

- The Bidder shall be in the business for at least the last (5) continuous years.
- The Bidder shall have implemented at least (3) similar contracts over the past (5) years.

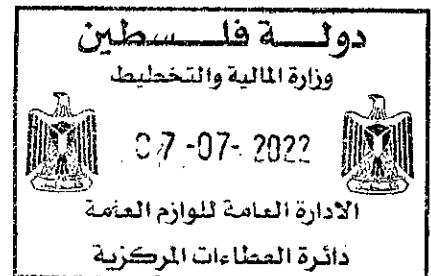

اثاث مدرسي

1. Maximum delivery period shall not exceed the maximum delivery periods stated below:

Contract Value (\$)	Maximum Delivery Period/ Days
600,000 - and Above	140
300,000 – 599,999	120
150,000- 299,999	90
50,000-149,999	75
20,000-49,999	45
Less than 20,000	30

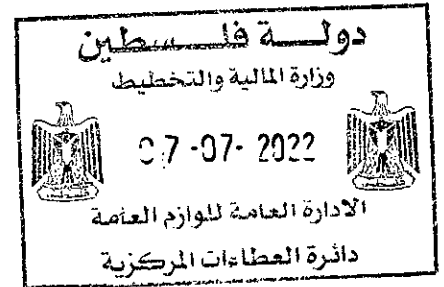

Section IV. Bidding Forms

Table of Forms

Declaration of Undertaking	35
Bidder Information Form.....	39
Joint Venture Partner Information Form.....	40
Bid Submission Form	41
Price Schedule Form.....	43
Manufacturer's Authorization	45



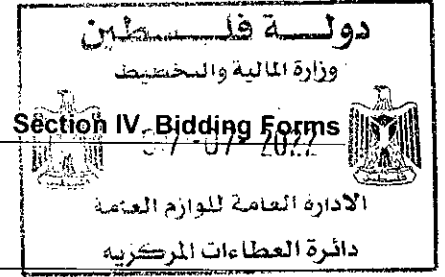

Declaration of Undertaking

Reference name of the Application/Offer/Contract:

("Contract")¹

To:

("Project Executing Agency")

1. We recognise and accept that JFA only finances projects of the Project Executing Agency ("PEA")² subject to its own conditions which are set out in the Funding Agreement it has entered into with the PEA. As a matter of consequence, no legal relationship exists between JFA and our company, our Joint Venture or our Subcontractors under the Contract. The PEA retains exclusive responsibility for the preparation and implementation of the Tender Process and the performance of the Contract.
2. We hereby certify that neither we nor any of our board members or legal representatives nor any other member of our Joint Venture including Subcontractors under the Contract are in any of the following situations:
 - 2.1) being bankrupt, wound up or ceasing our activities, having our activities administered by courts, having entered into receivership, reorganisation or being in any analogous situation;
 - 2.2) convicted by a final judgement or a final administrative decision or subject to financial sanctions by the United Nations, the European Union or Germany for involvement in a criminal organisation, money laundering, terrorist-related offences, child labour or trafficking in human beings; this criterion of exclusion is also applicable to legal Persons, whose majority of shares are held or factually controlled by natural or legal Persons which themselves are subject to such convictions or sanctions;
 - 2.3) having been convicted by a final court decision or a final administrative decision by a court, the European Union, national authorities in the Partner Country or in Germany for Sanctionable Practice in connection with a Tender Process or the performance of a Contract or for an irregularity affecting the EU's financial interests (*in the event of such a conviction, the Applicant or Bidder shall attach to this Declaration of Undertaking supporting information showing that this conviction is not relevant in the context of this Contract and that adequate compliance measures have been taken in reaction*);
 - 2.4) having been subject within the past five years to a Contract termination fully settled against us for significant or persistent failure to comply with our contractual

¹ Capitalised terms used, but not otherwise defined in this Declaration of Undertaking have the meaning given to such term in JFA "Guidelines for the Procurement of Consulting Services, Works, Plant, Goods and Non-Consulting Services in Financial Cooperation with Partner Countries".

² The PEA means the purchaser, the employer, the client, as the case may be, for the procurement of Consulting Services, Works, Plant, Goods or Non-Consulting Services.

Section IV. Bidding Forms

obligations during such Contract performance, unless this termination was challenged and dispute resolution is still pending or has not confirmed a full settlement against us;

- 2.5) not having fulfilled applicable fiscal obligations regarding payments of taxes either in the country where we are constituted or the PEA's country;
- 2.6) being subject to an exclusion decision of the World Bank or any other multilateral development bank and being listed on the website <http://www.worldbank.org/debarr> or respectively on the relevant list of any other multilateral development bank (*in the event of such exclusion, the Applicant or Bidder shall attach to this Declaration of Undertaking supporting information showing that this exclusion is not relevant in the context of this Contract and that adequate compliance measures have been taken in reaction*); or
- 2.7) being guilty of misrepresentation in supplying the information required as a condition of participation in the Tender.

3. We hereby certify that neither we, nor any of the members of our Joint Venture or any of our Subcontractors under the Contract are in any of the following situations of conflict of interest:

- 3.1) being an affiliate controlled by the PEA or a shareholder controlling the PEA, unless the stemming conflict of interest has been brought to the attention of JFA and resolved to its satisfaction;
- 3.2) having a business or family relationship with a PEA's staff involved in the Tender Process or the supervision of the resulting Contract, unless the stemming conflict of interest has been brought to the attention of JFA and resolved to its satisfaction;
- 3.3) being controlled by or controlling another Applicant or Bidder, or being under common control with another Applicant or Bidder, or receiving from or granting subsidies directly or indirectly to another Applicant or Bidder, having the same legal representative as another Applicant or Bidder, maintaining direct or indirect contacts with another Applicant or Bidder which allows us to have or give access to information contained in the respective Applications or Offers, influencing them or influencing decisions of the PEA;
- 3.4) being engaged in a Consulting Services activity, which, by its nature, may be in conflict with the assignments that we would carry out for the PEA;
- 3.5) in the case of procurement of Works, Plant or Goods:
 - i. having prepared or having been associated with a Person who prepared specifications, drawings, calculations and other documentation to be used in the Tender Process of this Contract;
 - ii. having been recruited (or being proposed to be recruited) ourselves or any of our affiliates, to carry out works supervision or inspection for this Contract;

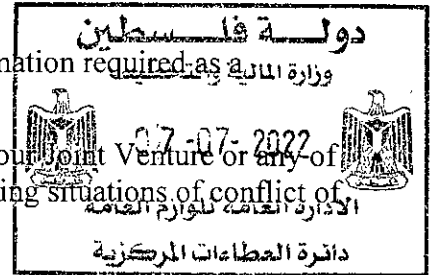

Section IV. Bidding Forms

4. If we are a state-owned entity, and compete in a Tender Process, we certify that we have legal and financial autonomy and that we operate under commercial laws and regulations.
5. We undertake to bring to the attention of the PEA, which will inform JFA, any change in situation with regard to points 2 to 4 here above.
6. In the context of the Tender Process and performance of the corresponding Contract:
- 6.1) neither we nor any of the members of our Joint Venture nor any of our Subcontractors under the Contract have engaged or will engage in any Sanctionable Practice during the Tender Process and in the case of being awarded a Contract will engage in any Sanctionable Practice during the performance of the Contract;
- 6.2) neither we nor any of the members of our Joint Venture or any of our Subcontractors under the Contract shall acquire or supply any equipment nor operate in any sectors under an embargo of the United Nations, the European Union or Germany; and
- 6.3) we commit ourselves to complying with and ensuring that our Subcontractors and major suppliers under the Contract comply with international environmental and labour standards, consistent with laws and regulations applicable in the country of implementation of the Contract and the fundamental conventions of the International Labour Organisation³ (ILO) and international environmental treaties. Moreover, we shall implement environmental and social risks mitigation measures when specified in the relevant environmental and social management plans or other similar documents provided by the PEA and, in any case, implement measures to prevent sexual exploitation and abuse and gender based violence.
7. In the case of being awarded a Contract, we, as well as all members of our Joint Venture partners and Subcontractors under the Contract will (i) upon request, provide information relating to the Tender Process and the performance of the Contract and (ii) permit the PEA and JFA or an agent appointed by either of them, and in the case of financing by the European Union also to European institutions having competence under European Union law, to inspect the respective accounts, records and documents, to permit on-the-spot checks and to ensure access to sites and the respective project.
8. In the case of being awarded a Contract, we, as well as all our Joint Venture partners and Subcontractors under the Contract undertake to preserve above mentioned records and documents in accordance with applicable law, but in any case for at least six years from the date of fulfillment or termination of the Contract. Our financial transactions and financial statements shall be subject to auditing procedures in accordance with

A. ³ In case ILO conventions have not been fully ratified or implemented in the Employer's country the Applicant/Bidder/Contractor shall, to the satisfaction of the Employer and KfW, propose and implement appropriate measures in the spirit of the said ILO conventions with respect to a) workers grievances on working conditions and terms of employment, b) child labour, c) forced labour, d) worker's organisations and e) non-discrimination.

Section IV. Bidding Forms

applicable law. Furthermore, we accept that our data (including personal data) generated in connection with the preparation and implementation of the Tender Process and the performance of the Contract are stored and processed according to the applicable law by the PEA and JFA.

Name: _____ In the capacity of: _____

Duly empowered to sign in the name and on behalf of⁴: _____

Signature:

Dated:

هام جدا: يجب تعبئة هذا النموذج

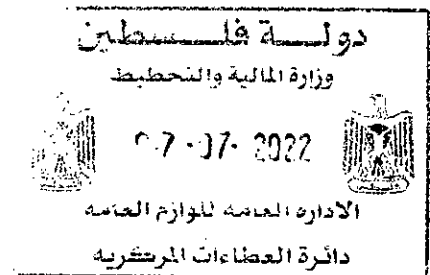

⁴ In the case of a JV, insert the name of the JV. The person who will sign the application, bid or proposal on behalf of the Applicant/Bidder shall attach a power of attorney from the Applicant/Bidder.

Bidder Information Form

[The Bidder shall fill in this Form in accordance with the instructions indicated below. No alterations to its format shall be permitted and no substitutions shall be accepted.]

Date: [insert date (as day, month and year) of Bid Submission]

ICB No.: [insert number of bidding process]

Page _____ of _____ pages

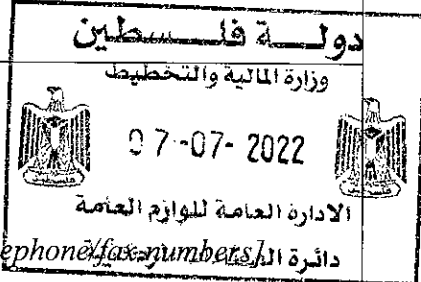
1. Bidder's Legal Name [insert Bidder's legal name]	
2. In case of JV, legal name of each party: [insert legal name of each party in JV]	
3. Bidder's actual or intended Country of Registration: [insert actual or intended Country of Registration]	
4. Bidder's Year of Registration: [insert Bidder's year of registration]	
5. Bidder's Legal Address in Country of Registration: [insert Bidder's legal address in country of registration]	
6. Bidder's Authorized Representative Information Name: [insert Authorized Representative's name] Address: [insert Authorized Representative's Address] Telephone/Fax numbers: [insert Authorized Representative's telephone/fax numbers] Email Address: [insert Authorized Representative's email address]	
7. Attached are copies of original documents of: [check the box(es) of the attached original documents]	
<input type="checkbox"/> Articles of Incorporation or Registration of firm named in 1, above, in accordance with ITB Sub-Clauses 4.1 and 4.2.	
<input type="checkbox"/> In case of JV, letter of intent to form JV or JV agreement, in accordance with ITB Sub-Clause 4.1.	
<input type="checkbox"/> In case of government owned entity from the GSD's country, documents establishing legal and financial autonomy and compliance with commercial law.	

Joint Venture Partner Information Form

[The Bidder shall fill in this Form in accordance with the instructions indicated below].

Date: [insert date (as day, month and year) of Bid Submission]

ICB No.: [insert number of bidding process]

Page _____ of _____ pages

1. Bidder's Legal Name: [insert Bidder's legal name]
2. JV's Party legal name: [insert JV's Party legal name]
3. JV's Party Country of Registration: [insert JV's Party country of registration]
4. JV's Party Year of Registration: [insert JV's Party year of registration]
5. JV's Party Legal Address in Country of Registration: [insert JV's Party legal address in country of registration]
6. JV's Party Authorized Representative Information Name: [insert name of JV's Party authorized representative] Address: [insert address of JV's Party authorized representative] Telephone/Fax numbers: [insert telephone/fax numbers of JV's Party authorized representative] Email Address: [insert email address of JV's Party authorized representative]
7. Attached are copies of original documents of: [check the box(es) of the attached original documents] <input type="checkbox"/> Articles of Incorporation or Registration of firm named in 2, above, in accordance with ITB Sub-Clauses 4.1 and 4.2. <input type="checkbox"/> In case of government owned entity from the GSD's country, documents establishing legal and financial autonomy and compliance with commercial law.

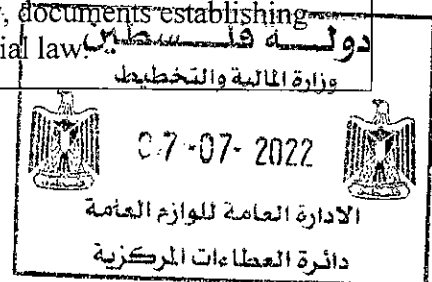

Bid Submission Form

[The Bidder shall fill in this Form in accordance with the instructions indicated No alterations to its format shall be permitted and no substitutions shall be accepted.]

Date: [insert date (as day, month and year) of Bid Submission]

ICB No.: [insert number of bidding process] دو

Invitation for Bid No.: [insert No. of IFB] وزارة

Alternative No.: [insert identification No if this is a Bid for an alternative]

To: [insert complete name of GSD]

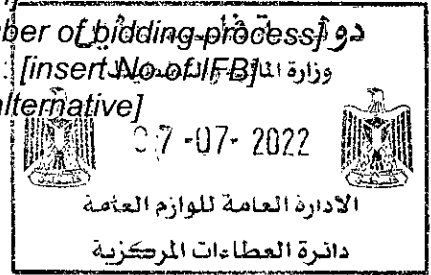

We, the undersigned, declare that:

- We have examined and have no reservations to the Bidding Documents, including Addenda No.: _____ [insert the number and issuing date of each Addenda];
- We offer to supply in conformity with the Bidding Documents and in accordance with the Delivery Schedules specified in the Schedule of Requirements the following Goods and Related Services _____ [insert a brief description of the Goods and Related Services];
- The total price of our Bid, excluding any discounts offered in item (d) below, is: _____ [insert the total bid price in words and figures, indicating the various amounts and the respective currencies];
- The discounts offered and the methodology for their application are:

Discounts. If our bid is accepted, the following discounts shall apply. _____ [Specify in detail each discount offered and the specific item of the Schedule of Requirements to which it applies.]

- Our bid shall be valid for the period of time specified in ITB Sub-Clause 20.1, from the date fixed for the bid submission deadline in accordance with ITB Sub-Clause 24.1, and it shall remain binding upon us and may be accepted at any time before the expiration of that period;
- If our bid is accepted, we commit to obtain a performance security in accordance with ITB Clause 44 and GCC Clause 17 for the due performance of the Contract;
- We, including any subcontractors or suppliers for any part of the contract, have nationality from eligible countries _____ [insert the nationality of the Bidder, including that of all

Section IV. Bidding Forms

parties that comprise the Bidder, if the Bidder is a JV, and the nationality each subcontractor and supplier]

- (h) We have no conflict of interest in accordance with ITB Sub-Clause 4.2;
- (i) Our firm, its affiliates or subsidiaries—including any subcontractors or suppliers for any part of the contract—has not been declared ineligible by the UN Security Council, under the GSD's country laws or official regulations, in accordance with ITB Sub-Clause 4.1;
- (k) We understand that this bid, together with your written acceptance thereof included in your notification of award, shall constitute a binding contract between us, until a formal contract is prepared and executed.
- (l) We understand that you are not bound to accept the lowest evaluated bid or any other bid that you may receive.

Signed: _____ *[insert signature of person whose name and capacity are shown]*
In the capacity of _____ *[insert legal capacity of person signing the Bid Submission Form]*

Name: _____ *[insert complete name of person signing the Bid Submission Form]*

Duly authorized to sign the bid for and on behalf of: _____ *[insert complete name of Bidder]*

Dated on _____ day of _____, _____ *[insert date of signing]*



Price Schedule Form

Section IV. Bidding Forms

Name of Bidder _____ Tender No. MOE-GSD/ JFA.8,13.312235/2022 /136
Page _____ of _____

NO	Item	Unit	Quantity	Unit price \$	TOTAL Price \$
Include A Group					
A-1	Student Desk4	Desk	2133		
A-2	Student Chair4	Chair	4695		
Group A sub total					
Include B Group					
B-1	Student Desk5	Desk	2221		
B-2	Student Chair5	Chair	4623		
Group B sub total					
Include C Group					
C-1	Student Desk6	Desk	2300		
C-2	Student Chair6	Chair	5651		
Group C sub total					
Include D Group					
D-1	Teacher Desk (Classroom)	Desk	333		
D-2	Teacher Desk (staff room)	Desk	658		
D-3	Teacher Chair	Chair	768		
D-4	Reading Table	Table	57		
D-5	Working Table	Table	10		
D-6	Technology lab.bench	Table	6		
D-7	Computer Table (student)	Table	388		
D-8	Student Drawing Table	Table	30		
Group D sub total					
Include E Group					
E-1	Headmaster/Officer Desk 75X70X150	Desk	87		
E-2	Officer Desk 75X60X120	Desk	98		
E-3	Computer Table(Wooden)	Table	60		
E-4	Book Shelves	Cabinet	126		
E-5	Wooden closet shelves with two bottom doors	Cabinet	72		
Group E sub total					

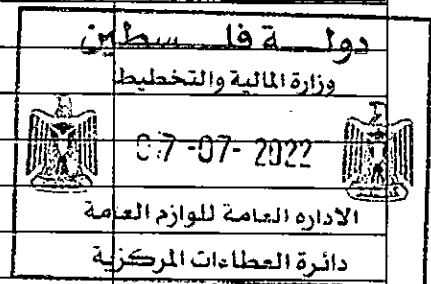

Section IV. Bidding Forms

Include F Group					
F-1	Headmaster/Officer Chair	Chair	146		
F-2	multipurpose chair	Chair	746		
F-3	Stool Chair	Chair	640		
Group F sub total					
Include G Group					
G-1	Metal File Cabinet (4 Drawers)	Cabinet	60		
G-2	Metal Cabinet (2 Doors)	Cabinet	130		
Group G sub total					
Grand Total \$ excluding tax					

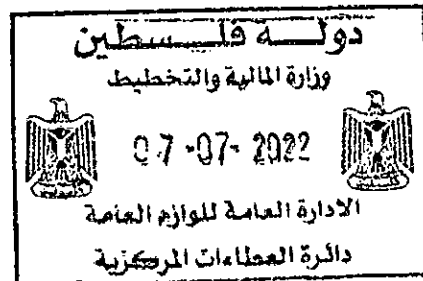

Bid Security Form

To: Ministry of Finance
Palestinian Authority

Date: _____

Contract Name: *Supply and Delivery of School Furniture*
Contract No.: **MOE-GSD/ JFA.8,13.312235/2022 /136**

Gentlemen and/or Ladies:

We, the undersigned (Guarantor), in order to enable to bid for
(**Manufacture and supply school furniture / West Bank**) hereby irrevocably and
independently guarantee to pay to you an amount up to a total of

(In words:)

Waiving all objections and defenses

We shall effect payments under this guarantee on your first written demand, which must be
accompanied by your confirmation that you have accepted the above-mentioned bid and that the
firm is no longer prepared to abide by this bid.

This guarantee shall expire not later than

By this date we must have received any claims by letter or encoded telecommunication.

It is understood that you will return this guarantee to us on expiry or after payment of the total
amount to be claimed hereunder.

This guarantee is governed by the law of the Palestinian Authority.

.....
Place, date

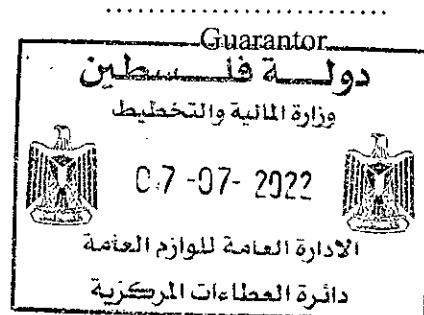

Manufacturer's Authorization

Section IV. Bidding Forms

[The Bidder shall require the Manufacturer to fill in this Form in accordance with the instructions indicated. This letter of authorization should be on the letterhead of the Manufacturer and should be signed by a person with the proper authority to sign documents that are binding on the Manufacturer. The Bidder shall include it in its bid, if so indicated in the **BDS**.]

Date: [insert date (as day, month and year) of Bid Submission]

ICB No.: [insert number of bidding process]

Alternative No.: [insert identification No if this is a Bid for an alternative]

To: [insert complete name of GSD]

WHEREAS

We [insert complete name of Manufacturer], who are official manufacturers of [insert type of goods manufactured], having factories at [insert full address of Manufacturer's factories], do hereby authorize [insert complete name of Bidder] to submit a bid the purpose of which is to provide the following Goods, manufactured by us [insert name and or brief description of the Goods], and to subsequently negotiate and sign the Contract.

We hereby extend our full guarantee and warranty in accordance with Clause 27 of the General Conditions of Contract, with respect to the Goods offered by the above firm.



Signed: [insert signature(s) of authorized representative(s) of the Manufacturer]

Name: [insert complete name(s) of authorized representative(s) of the Manufacturer]

Title: [insert title]

Dated on _____ day of _____, _____ [insert date of signing]

PART 2 – Supply Requirements

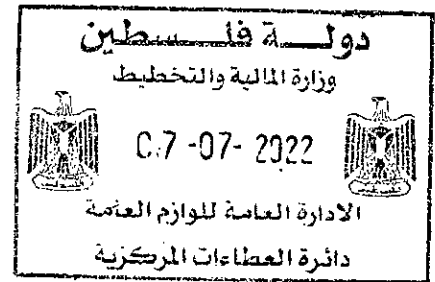

Section VI. Schedule of Requirements

Contents

PART 1 – Bidding Procedures	3	2
Invitation for Bids (IFB)	5	2
PART 2 – Supply Requirements	47	2
Section VI. Schedule of Requirements	48	2
PART 1 – Bidding Procedures		3
Invitation for Bids (IFB)		5
A. General	8	6
B. Contents of Bidding Documents	10	6
C. Preparation of Bids	11	6
D. Submission and Opening of Bids	17	6
E. Evaluation and Comparison of Bids	20	7
F. Award of Contract	24	7
Declaration of Undertaking	35	34
Bidder Information Form	39	34
Joint Venture Partner Information Form	40	34
Bid Submission Form	41	34
Price Schedule Form	43	34

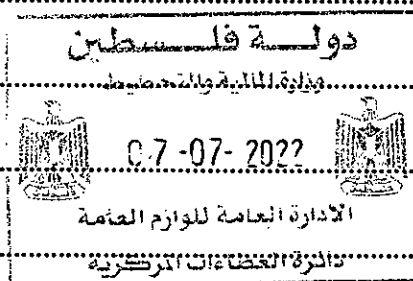

Manufacturer's Authorization 46	34
Declaration of Undertaking	35
PART 2 – Supply Requirements	47
Section VI. Schedule of Requirements.....	48
1. Delivery Schedule	50
1. Contract Agreement 74	118
2. Performance Security Form 76	118
3. Standard Form of an Advance Payment Bond 77.....	118

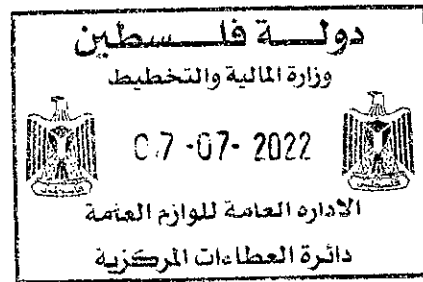



1. Delivery Schedule

Goods shall be delivered to the destinations and in the quantities furnished in the following tables:

School Furniture / Directorate of Education / JFA / 2022																						
NO	نوع الأثاث	Item	Unit	Jenin	Cabatiya	Tubas	Tulkarm	Nablus	S.Nablus	Saffat	Qalqilya	Ramallah	Birzeit	Jerico	Airam	Jerusalem	Bethlehem	N.Hebron	Hebron	S.Hebron	Yatta	Total Quantity
A-1	طاولة مكتب جد-4	Student Desk4	Desk	140	100	25	100	150	0	202	40	150	70	20	65	20	200	200	300	250	101	2133
A-2	كرسي مكتب جد-4	Student Chair4	Chair	300	200	50	200	300	0	400	100	500	198		355	42	200	400	600	650	200	4695
B-1	طاولة مكتب جد-5	Student Desk5	Desk	150	101	70	175	150	120	100	50	150	80	20	65	40	150	200	300	200	100	2221
B-2	كرسي مكتب جد-5	Student Chair5	Chair	400	199	142	300	300	240	197	100	300	210	50	355	80	150	400	600	400	200	4623
C-1	طاولة مكتب ز-ج/6	Student Desk6	Desk	120	99	20	300	200	160	0	50	150	85	21	65	80	100	200	400	150	100	2300
C-2	كرسي مكتب ز-ج/6	Student Chair6	Chair	500	200	40	1000	500	320	0	100	440	200	35	355	160	100	500	800	201	200	5651
D-1	طاولة معلم في غرفة لصف	Teacher Desk (Classroom)	Desk	30	20	8	0	40	0	0	0	0	5	10	10	10	100	0	30	70	0	333
D-2	طاولة معلم في غرفة المعلمين	Teacher Desk (staff room)	Desk	80	20	20	20	40	45	16	100	50	5	7	0	0	100	45	40	70	0	658
D-3	كرسي معلم	Teacher Chair	Chair	40	100	25	50	0	30	0	100	50	20	40	0	21	102	0	40	150	0	768
D-4	طاولة مكتبة	Reading Table	Table	0	15	0	10	15	0	0	0	0	4	0	0	0	0	0	10	3	0	57
D-5	طاولة عمل تنظير لفتح	Working Table	Table	0	10	0	0	0	0	0	0	0	0	0	0	0	0	0	0	0	0	10
D-6	طاولة عمل مختبر لتكنولوجيا	Technology lab.bench	Table	0	0	0	0	4	0	0	0	0	2	0	0	0	0	0	0	0	0	6
D-7	طاولة كمبيوتر (طالب)	Computer Table(student)	Table	40	50	18	0	40	30	2	0	40	8	20	0	0	10	50	50	20	10	388
D-8	طاولة رسم	Student Drawing Table	Table	0	0	0	0	0	0	0	30	0	0	0	0	0	0	0	0	0	0	30
E-1	مكتب مدير مدرسة 75x70x150	Headmaster/Officer Desk 75X70X15	Desk	0	5	4	0	20	10	0	5	5	5	0	0	5	15	0	10	0	3	87
E-2	مكتب موظف 75x60x120	Officer Desk 75X60X120	Desk	12	5	4	0	10	0	0	5	15	5	2	0	0	15	0	5	10	10	98
E-3	طاولة خشب خشبية	Computer Table(Wooden)	Table	0	0	4	10	5	0	0	10	5	4	0	0	0	9	0	2	0	10	60
E-4	رفوف مكتبة	Book Shelves	Cabinet	0	20	8	10	20	0	0	10	10	8	5	0	0	0	0	10	15	10	126
E-5	رفوف خشب مع قفصين سفليين	Wooden closet shelves with two bottom doors	Cabinet	0	0	4	0	20	10	0	10	5	3	0	0	0	5	0	5	0	10	72
F-1	كرسي موظف مدير مدرسة	Headmaster/Officer Chair	Chair	0	0	7	0	10	20	20	20	15	5	0	0	7	12	0	10	10	10	146
F-2	كرسي تنظير	multipurpose chair	Chair	68	25	20	0	203	32	50	18	60	10	0	0	20	50	70	40	50	30	746
F-3	كرسي سفوف	Stool Chair	Chair	20	100	0	0	100	0	0	100	100	40	0	0	0	0	0	50	100	30	640
G-1	خزانة معدنية 4 جوارير	Metal File Cabinet (4 Drawers)	Cabinet	0	0	1	10	10	0	0	5	5	3	0	0	0	8	0	10	5	2	60
G-2	خزانة معدنية بابين	Metal Cabinet (2 Doors)	Cabinet	15	4	4	0	20	10	19	3	10	2	4	0	4	0	10	5	10	10	130

المواصفات الفنية

Headmaster / Officer Chair

A. General

For 1 person

B. Technical Specifications

1. Metal framework

A swivel chair with 5 rolling wheels.

Adjustable armrest shall be made of reinforced plastic and covered with rubber.

The seat shall be connected to the base by a chromium rod not less than 30 cm long and 5 cm in diameter.

2. Chair back

Made of special material (plastic) for chair back to be comfortable.

Special, good quality net type cloth shall be used for covering the chair back.

The color shall be black.

Provided with adjustable cushion specially for chair back to be comfortable and adjustable a neck rest at the top of chair back.

3. Chair seat

Shall be made of pre-cut wood (sandwich) (15mm thickness) grade A.

Shall be upholstered using sponge (5cm thickness) strong pressure type.

Covered with special good quality of cloth (black color).

Provided with special nuts fixed in wooden seat to fix it with metal framework (propeller) chair back.

A device (propeller) shall be installed at to control the inclination process forwards and backwards and a jack for elevation adjustment.

4. Marking of goods:

The supplier shall put his commercial mark on all supplied pieces of goods by stamp or by fixing a sticker properly – approved by the Ministry- on the bottom face of the goods, this mark shall contain the name of the factory, tender No. and the financial resource, in a clear and permanent manner and approved by Ministry.

5. Packing:

a-It should be backed unassembled using special cardboard for this type of furniture.

b-The supplier shall assemble the furniture at his expenses and responsibility, at the assigned places according to distribution table.



Headmaster / Officer Chair

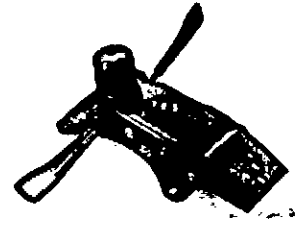
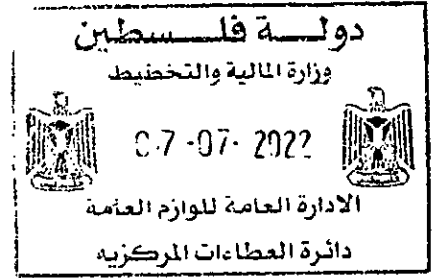

Teacher Chair

A. General

In Classroom, and staff room use

B. Technical Specifications

Height: 46 cm

Dimension of plastic seat: 42 x 43 cm

Dimension of plastic back: 22 x 43 cm

Plastic thickness: 5 - 8 mm

Plastic color: grey.

Diameter of iron profile: (20x20) mm

Thickness of iron profile: 1.25mm



Note: for plastic dimensions measured by cms (± 0.5) cm

1. Metal framework

The metal framework shall be made from profile. Diameter: (20x20) mm, thickness 1.25 mm.

All ends of metal profile shall be closed with plastic covers.

Plastic heels are to be installed at the bottom of the chair's legs.

All metal frame work shall be welded together properly, strongly and in conformity with regulations.

CO2 welding shall be used

2. Chair back and seat

-(Samples are available for bidders, to manufacture plastic parts with same chemical composition, same hardness, shape and thickness)

-Chair back and seat shall be made out of reinforced plastic. Thickness: 5-8mm.

-The chair back shall be fixed by metal screw; length 3.5cm, required number: 2.

It shall be fixed from the backside.

-The seat shall be fixed by metal screw; length: 3.5 cm required number: 2.

-Strength for the plastic material of chair parts shall be according to international standards for this product .

-High flexibility for shocks resistant according to international standards for this product.

-Safe material for human touching that does not contain any mercury, lead, or any other harming materials.

-Made of first class raw materials, non recycled, and free of any cancerous materials.

-Resistant to direct sunlight for more than 4 years.

3. Painting

- All metal shall be painted after applying anticorrosive treatment with atleast three stages and cleaned from oil, grease, dust, and other dirt using special thermal control painting for metal furniture to form a layer of base painting of (iron phosphate) (0.4 – 0.8) gm/m².

- Automatic spray painting shall be applied to be followed by a drying process in a thermal furnace with suitable temperature and time for the process.

- Thickness of painting (60 – 80) micron.

-(Aboxpolyster powder) paint should be used, color: Marengo No. 7016

Painting of iron, assembly, delivery and storage must be carried out away from climatic influence i.e. sun, dust etc.

4. Marking of goods:

- a. The supplier shall put his commercial mark on all supplied pieces of goods by stamp or by fixing a sticker properly –approved by the Ministry- on the bottom face of the goods, this mark shall contain the name of the factory, tender No. and the financial resource, in a clear and permanent manner and approved by Ministry.
- b. Plastic parts of student and teacher chairs shall be marked thermally by sign (factory name) built in the template , approved by Ministry .

5. Packing:

The supplied goods shall be backed by using special plastic sheets (with air babbles) to prevent scratching of paintings and surfaces of goods.

6. Inspections and tests:

The MEHE has the right to test sample of this item at specialized labs or institutions at the Palestinian Authority area or nearby countries, at the supplier's expenses before and /or after bid award.



Teacher Chair

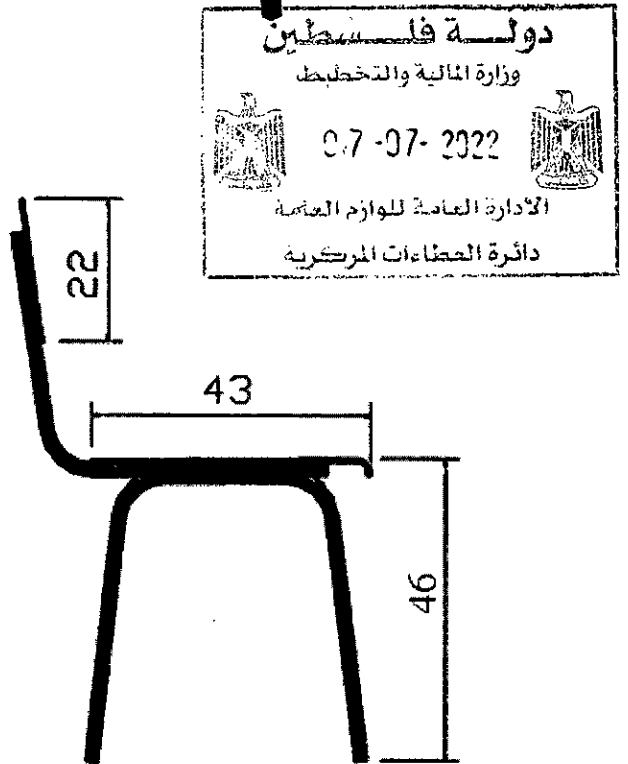
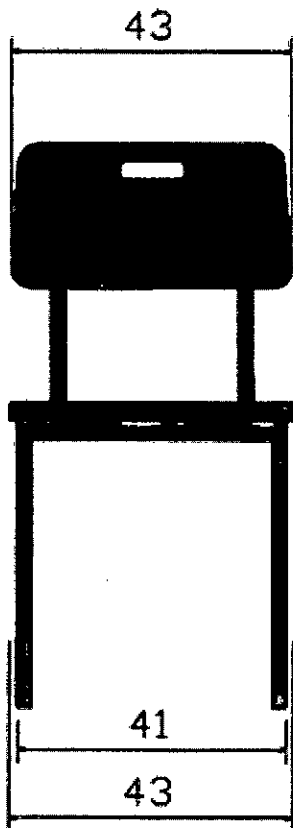
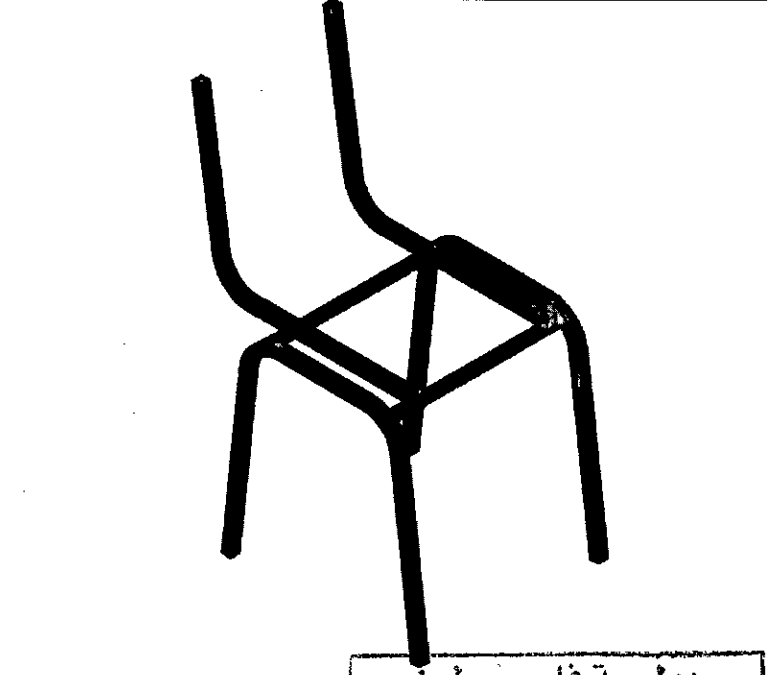
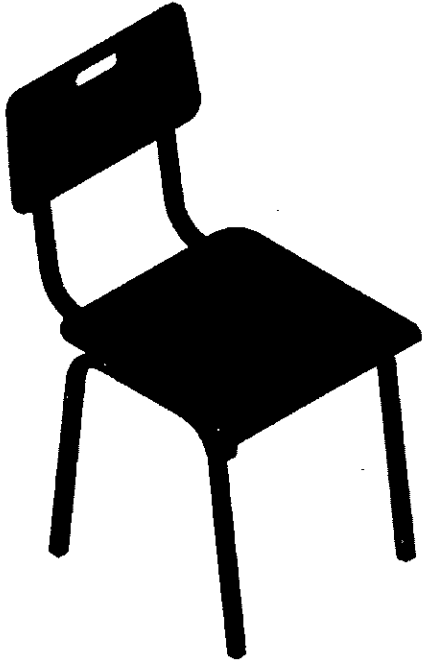

Computer Table (Student)

A. General

For student use

B. Technical Specifications

1. Metal Frame Work

The metal frame shall be made from hollow metal profile tubes.

Dimension: 20 x 20 mm and 40 x 20 mm, thickness: 1.25 mm.

All metal pieces shall be welded together properly, strongly and in conformity with regulations. CO2 welding shall be used.

Additional holes in the metal framework shall be made besides and equal in number to the original holes to enable future maintenance.

All ends of the metal squares must be covered with black plastic covers.

Plastic heels are to be installed under the legs to elevate the metal frame from the ground and must be fixed with galvanized metal screws.

2. Table Board

The table board shall be made of precut plywood (SANDWICH), best quality.

Thickness of table board shall be 17 mm, dimensions: 110 x 54 cm. It shall be covered with colored plastic FORMICA on both sides.

Top Formica thickness: 0.8mm. Colour: grey (3130)

Bottom Formica thickness: 0.5mm.

The table board shall be belted using INJECTION POLYURETHANE THERMOSET.

The belt thickness must be (5- 8mm). Colour: black

The table board shall be fixed on the metal framework using galvanized metal screws, (3.5 cm).

Number of screws: 12. It should be fixed from the bottom.

-Raw materials should be flexible.

-The polyethylene materials should not be used due to harmful material.

-The materials that will be used for manufacturing are similar to these used globally for manufacturing food containers, which means it is safe to be used.

-The used dyes and raw materials should be free of any cancerous materials.

-Strength for the disk top should be high "not less than 250 kg".

Keyboard Holder

Two-piece of sheet metal 1.5 mm thick shall be centrally welded to the upper frame of the table to hold the keyboard shelf.

One piece of sheet metal 1.5 mm thick shall be welded at the front of the table.

In this piece, a hole 5 cm in diameter shall be made and covered with a hard plastic ring.

A shelf made of plywood(sandwich) with thickness of 17 mm, 60 x 45 cm covered with stretched laminating (thickness 2 mm).

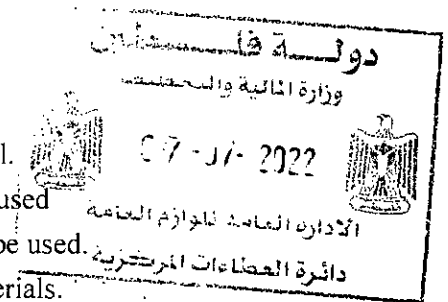

This shelf shall be belted from front with wooden natural wood (U) shape. Colour: black.

The shelf shall move on painted metal rails 1.25 mm thick and wheels.

3. Painting

- All metal shall be painted after applying anticorrosive treatment with at least three stages and cleaned from oil, grease, dust, and other dirt using special thermal control painting for metal furniture to form a layer of base painting of (iron phosphate) (0.4 – 0.8) gm/m².
 - Automatic spray painting shall be applied to be followed by a drying process in a thermal furnace with suitable temperature and time for the process.
 - Thickness of painting (60 – 80) micron.
 - (Epoxy polyester powder) paint should be used, colour: Marengo No. 7016
- Painting of iron, assembly, delivery and storage must be carried out away from climatic influence i.e. sun, dust etc.

4. Marking of goods:

The supplier shall put his commercial mark on all supplied pieces of goods by stamp or by fixing a sticker properly –approved by the Ministry- on the bottom face of the goods, this mark shall contain the supplier name, tender No. and the financial resource, in a clear and permanent manner and approved by Ministry.

5. Packing:

The supplied goods shall be backed by using special plastic sheets (with air babbles) to prevent scratching of paintings and surfaces of goods .

6. Inspections and tests:

The MEHE has the right to test sample of this item at specialized labs or institutions at the Palestinian Authority area or nearby countries, at the supplier's expenses before and /or after bid award.



Computer Table (Student)

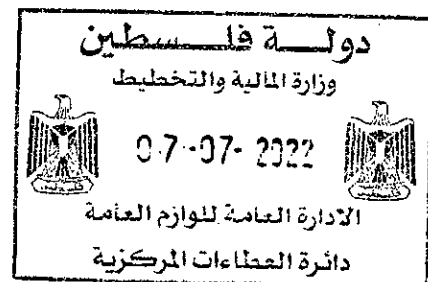
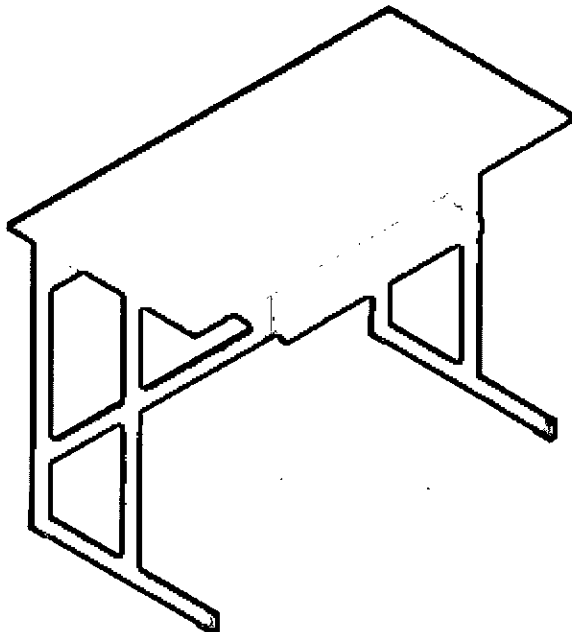
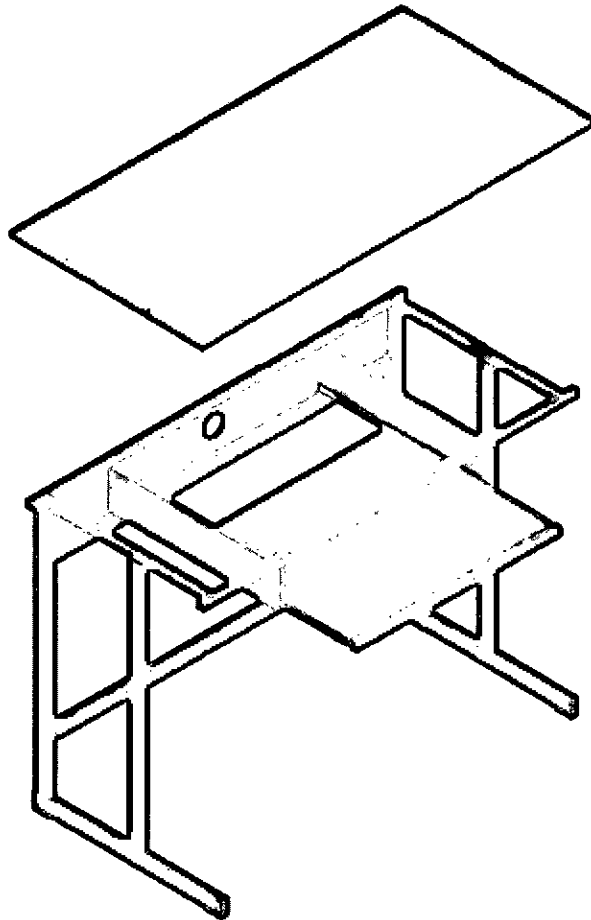

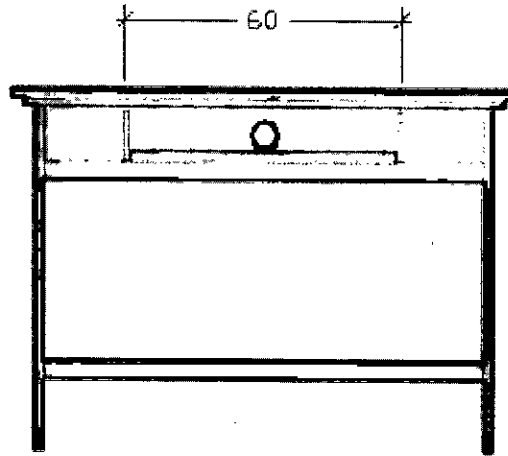
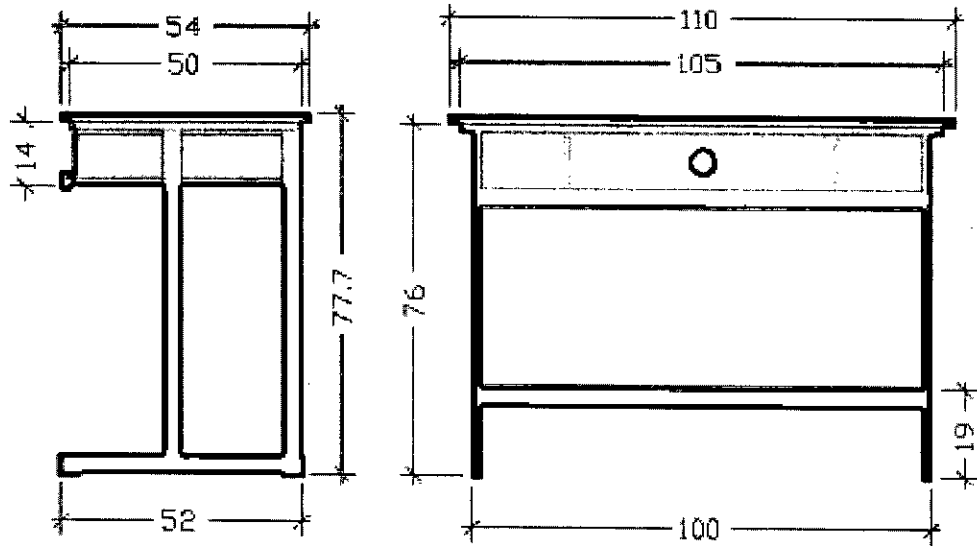

Stool chair

A. General

B. Technical Specifications

1. Chair Frame and Seat

Height: 60 cm .

Four-legged stool chair.

The legs shall be made of metal profile pipe 22 mm in diameter and 1.25 mm thick as shown on attached figure.

The chair shall have two rings made of metal profile pipes of 16 mm in diameter and 1.25 mm in thickness.

All metal parts shall be welded using CO2 continuous welding.

The seat shall have a disc-like shape, diameter 34 cm made of Natural Sweden wood 34 mm thick, painted with lacquer paint OR disk-like shape concave diameter 34 cm made out of reinforced plastic.

Thickness 3-5mm ,weight not less than 500gm

The seat shall be fixed to the metal framework by using galvanized metal screws, (3 cm).

Number of screws: 4.

Plastic heels are to be installed under the chair at the metal open ends.

2. Painting

- All metal shall be painted after applying anticorrosive treatment with at least three stages and cleaned from oil, grease, dust, and other dirt using special thermal control painting for metal furniture to form a layer of base painting of (iron phosphate) (0.4 – 0.8) gm/m².
 - Automatic spray painting shall be applied to be followed by a drying process in a thermal furnace with suitable temperature and time for the process.
 - Thickness of painting (60 – 80) micron.
 - (Epoxy polyester powder) paint should be used, colour: Marengo No. 7016
- Painting of iron, assembly, delivery and storage must be carried out away from climatic influence i.e. sun, dust etc.

4. Marking of goods:

- a. The supplier shall put his commercial mark on all supplied pieces of goods by stamp or by fixing a sticker properly –approved by the Ministry- on the bottom face of the goods, this mark shall contain the supplier name, tender No. and the financial resource, in a clear and permanent manner and approved by Ministry.

5. Packing:

The supplied goods shall be backed by using special plastic sheets (with air babbles) to prevent scratching of paintings and surfaces of goods .



Stool

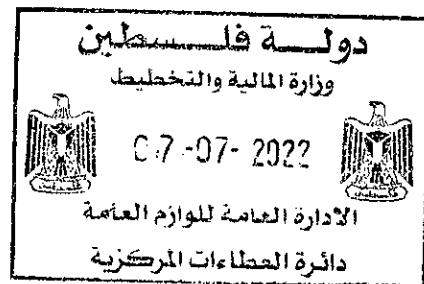
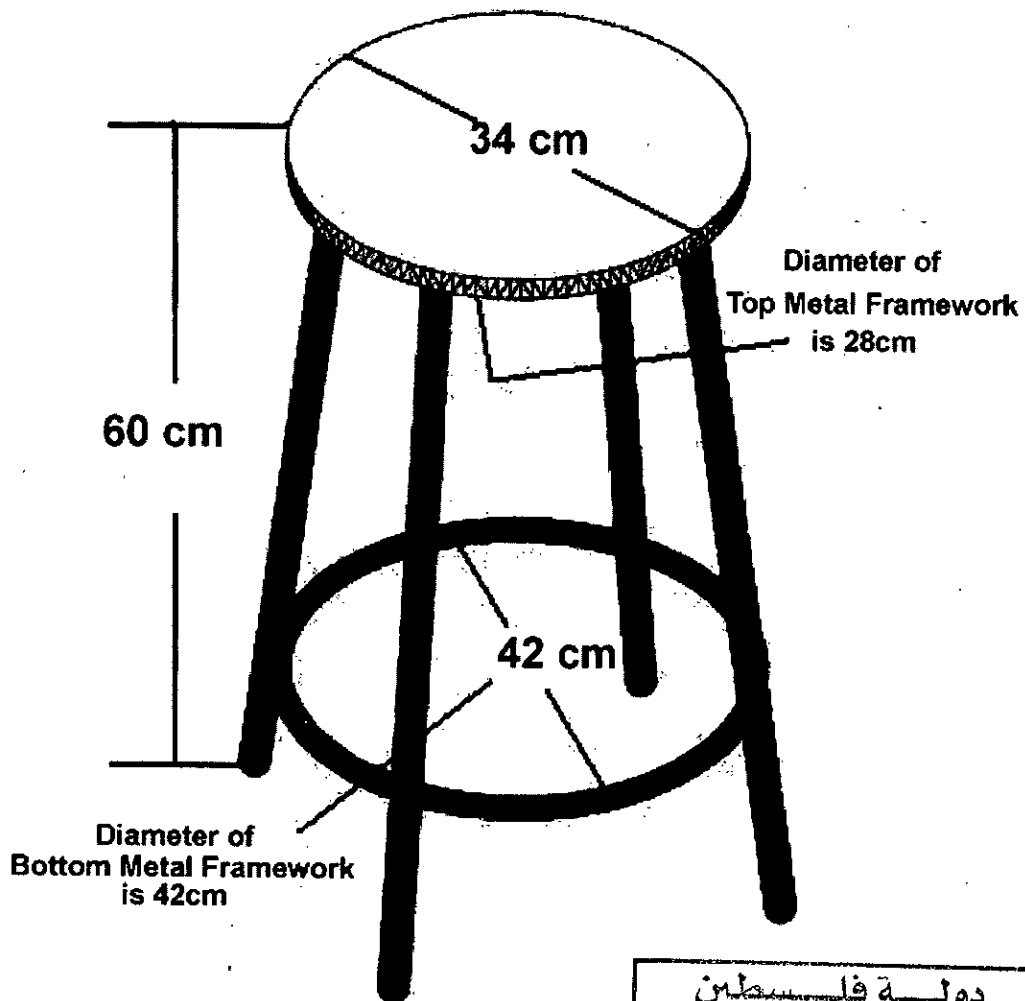

Teacher Desk (in staff room)

A. General

In staff room use

B. Technical Specifications

1. Metal framework

The metal framework shall be made from hollow squared steel profile tubes 25 x 25mm and 1.25 mm thick.

A drawer made of metal sheet 0.8mm thick shall be installed with lock and Chromium coated handle.

Metal rails made of metal 1.25 mm thick with metal wheels on both sides for the drawer to slide on.

A metal sheet cover 0.8 mm thick and width of 130 mm shall be installed around the level of the drawer.

The bottom edges of the metal frame shall be covered with plastic heels.

All metal pieces are to be welded together properly, strongly and in conformity with regulations.

CO2 welding shall be used. Plastic heels are to be installed under the legs to elevate the iron parts from the ground.

2. Table board

The table board shall be made of "sandwich" wood, best quality.

Thickness of plywood is 17 mm, dimensions: 100 x 60 cm.

It shall be covered with stretched laminated plastic sheets (Formica) 0.8 mm thick. Color: Gray (3130).

The table board shall be thickened by using strips of plywood (sandwich) wood 17 x 50 mm around the backside edges of the table's board.

Beech wood shall be used in belting the edges of the table board 15 mm thick and 34 mm wide.

The beech belt shall be fixed by using adhesives of best quality and after fixing of Formica to the board.

The beech belt shall be painted with three coats of lacquer paint in addition to a prime coat and to be fixed by using adhesive materials with no nailing.

The table board shall be fixed on the metal framework using galvanized metal screws. Number of screws: 10.

Formica type is "MATT".

3. Painting

- All metal shall be painted after applying anticorrosive treatment with at least three stages and cleaned from oil, grease, dust, and other dirt using special thermal control painting for metal furniture to form a layer of base painting of (iron phosphate) (0.4 – 0.8) gm/m².

- Automatic spray painting shall be applied to be followed by a drying process in a thermal furnace with suitable temperature and time for the process.

- Thickness of painting (60 – 80) micron.

- (Aboxpolyster powder) paint should be used, colour: Marengo No. 7016

Painting of iron, assembly, delivery and storage must be carried out away from climatic influence i.e. sun, dust etc.

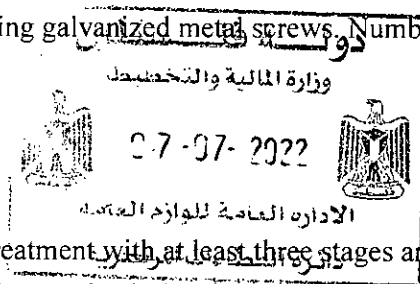

4. Marking of goods:

a. The supplier shall put his commercial mark on all supplied pieces of goods by stamp or by fixing a sticker properly –approved by the Ministry- on the bottom face of the goods, this mark shall contain the name of the factory, tender No. and the financial resource, in a clear and permanent manner and approved by Ministry.

5. Packing:

The supplied goods shall be backed by using special plastic sheets (with air babbles) to prevent scratching of paintings and surfaces of goods .

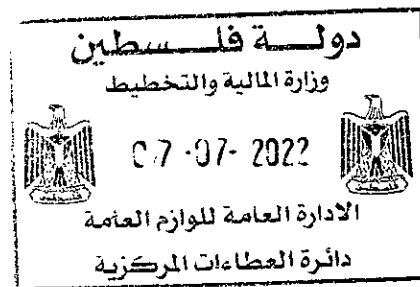
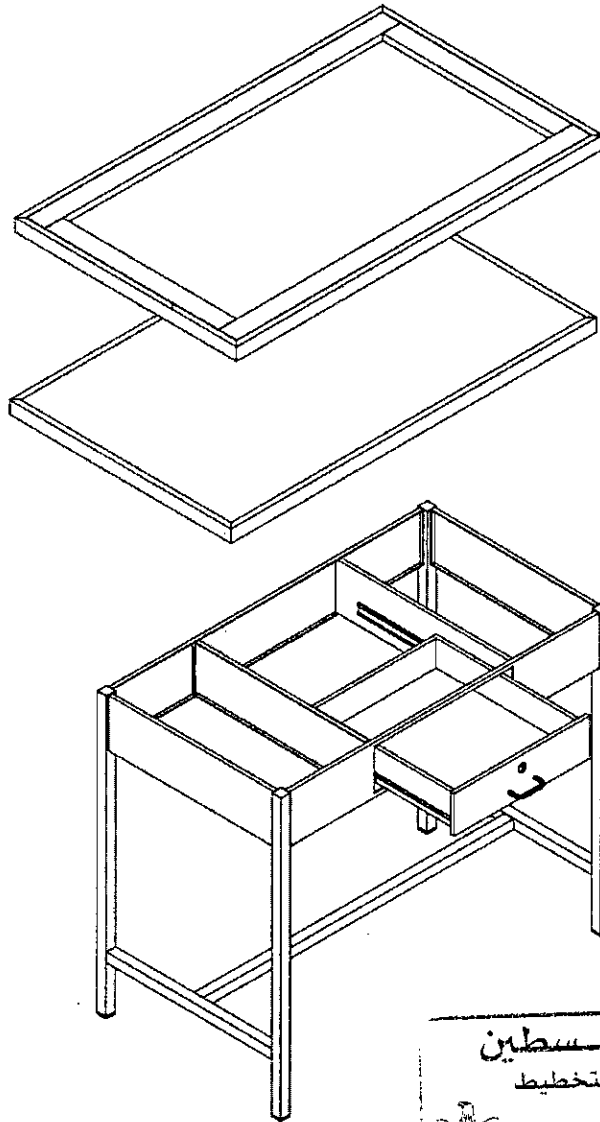

Teacher Desk (Staffroom)

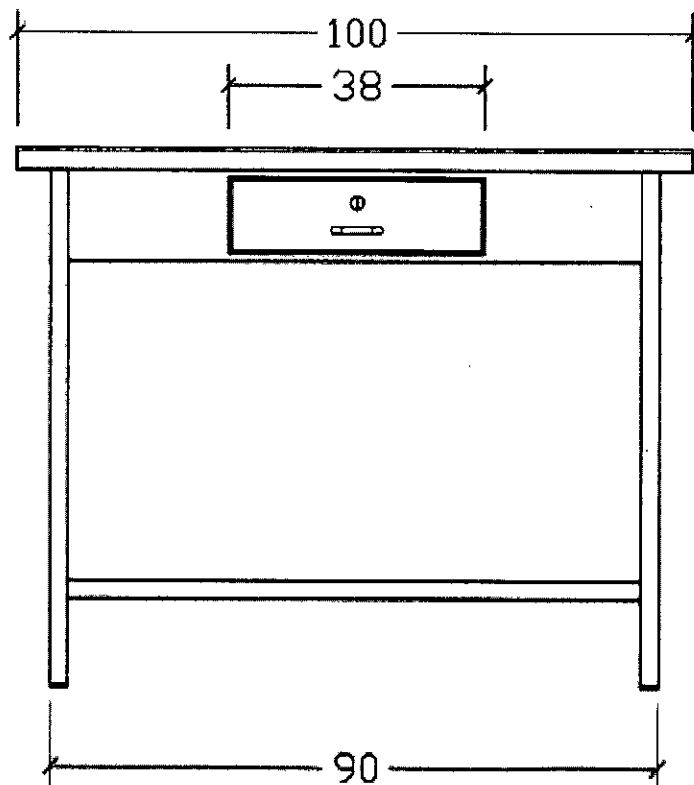
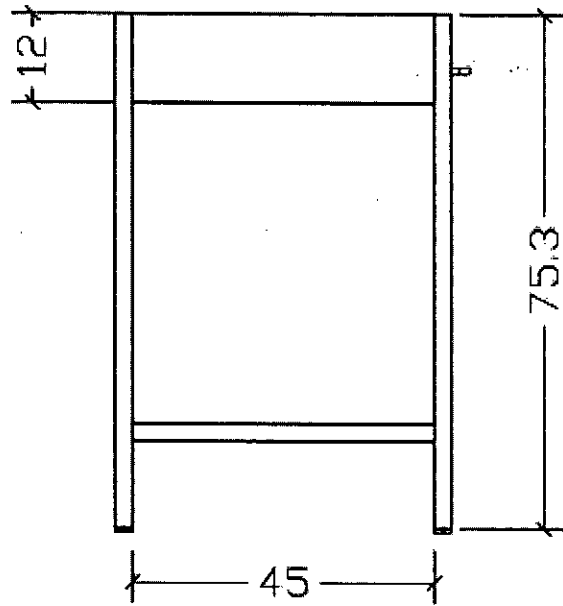
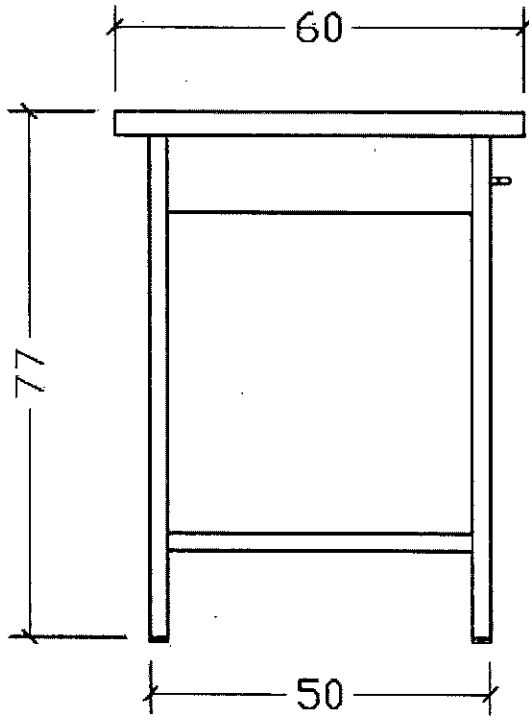

Metal Cabinet (2 Doors)

A. General

B. Technical Specifications

1. Metal framework

The whole metal framework shall be made of metal sheets with a minimum thickness of 0.8 mm including the back of the cabinet and the internal shelves.

All metal pieces are to be welded together properly, strongly and in conformity with regulations, by using Co2andpoint welding.

Plastic heels shall be fixed at the bottom of the cabinet.

2. Dimensions

Length: 193 cm, Width: 90 cm, Depth: 43 cm.

3. Internal division

Four movable shelves shall be internally installed with four graduated supports.

4. Doors

Two doors for the cabinet shall be installed with properly movable hinge pillars all over the side length of the door.

The doors shall be reinforced in the middle with a metal sheet bar with a minimum width of 20 cm each door having (٢)

A cylindrical lock shall be installed made of chrome with triple closing directions (top, bottom, side).

5. Painting

- All metal shall be painted after applying anticorrosive treatment with at least three stages and cleaned from oil, grease, dust, and other dirt using special thermal control painting for metal furniture to form a layer of base painting of (iron phosphate) (0.4 – 0.8) gm/m².
- Automatic spray painting shall be applied to be followed by a drying process in a thermal furnace with suitable temperature and time for the process.
- Thickness of painting (60 – 80) micron.
- (Epoxy polyester powder) paint should be used, colour: beige (3010) and brown (6418)

Painting of iron, assembly, delivery and storage must be carried out away from climatic influence i.e. sun, dust etc.

6. Marking of goods:

The supplier shall put his commercial mark on all supplied pieces of goods by stamp or by fixing a sticker properly –approved by the Ministry- on the bottom face of the goods, this mark shall contain the supplier name, tender No. and the financial resource, in a clear and permanent manner and approved by Ministry.

7. Packing:

The supplied goods shall be backed by using special plastic sheets (with air babbles) or special card board to prevent scratching of paintings and surfaces of goods.

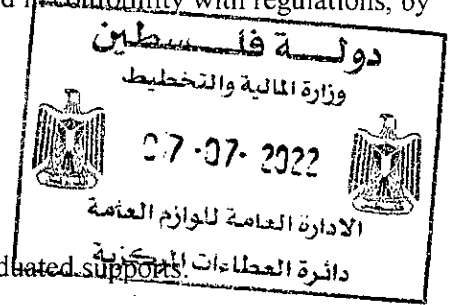

Metal Cabinet (2 Doors)

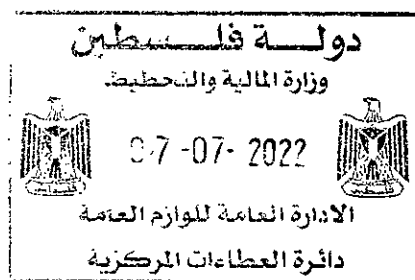
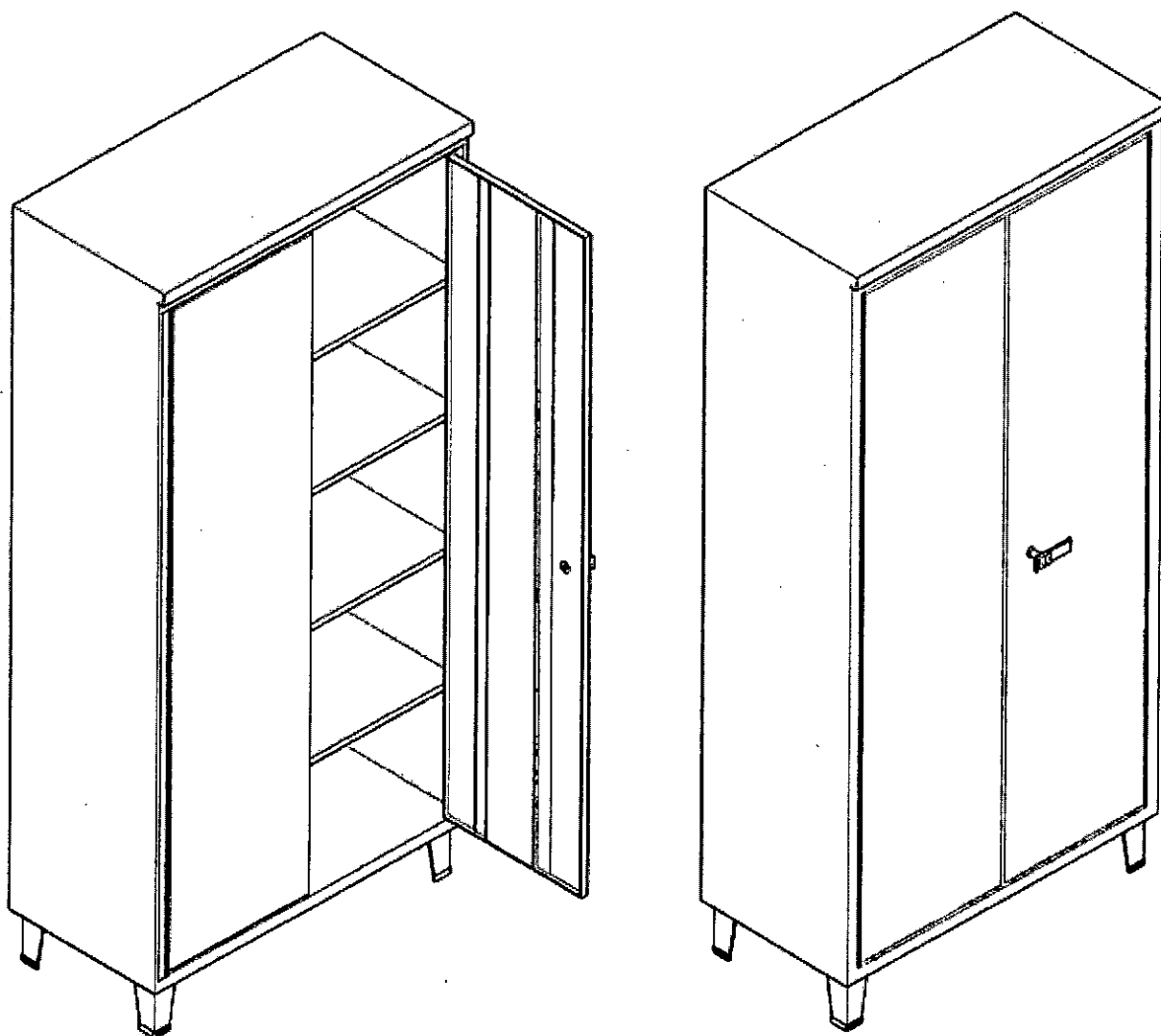

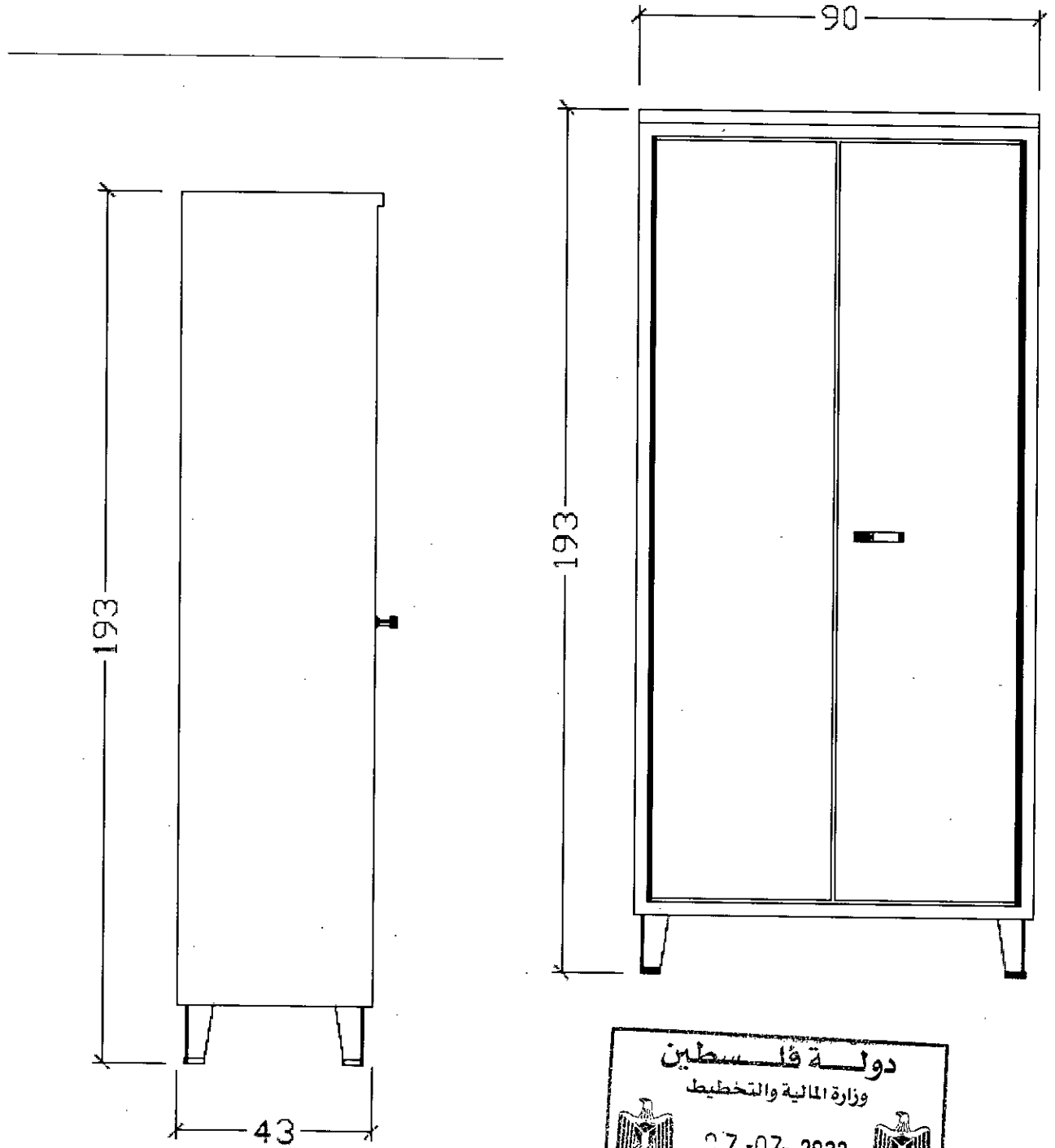

Student Desk 4

A. General

For 2 pupils.

B. Technical Specifications

Height, 64 cm

Dimension of table board: 45 x 115 cm

Thickness of table board: 17mm

Dimension of metal-tubes: 20 x 20 mm & 40 x 20 mm

Thickness of metal sheets forming the metal tube: 1.25 mm

Color of the surface of table board (Formica): grey (3130)

1. Metal framework

The metal frame shall be made from hollow metal profile tubes.

Dimensions: 20 x 20 mm and 40 x 20 mm, thickness: 1.25 mm.

All metal pieces shall be welded together properly, strongly and in conformity with regulations.

CO2 welding shall be used.

Additional holes in the metal framework shall be made besides and equal in number to the existing holes to enable future maintenance.

All ends of the metal squares must be closed with black plastic covers.

Plastic heels are to be installed under the legs to elevate the iron parts from the ground and must be fixed with metal screws.

Two bag-holders should be fitted at each side of table.

2. Table board

The table board shall be made of precut plywood (SANDWICH), best quality.

Thickness of table board shall be 17 mm, dimensions: 115 x 45 cm. It shall be covered with colored plastic FORMICA on both sides.

Top Formica thickness: 0.8mm. Colour: grey (3130)

Bottom Formica thickness: 0.5mm. Color: white

The table board shall be belted using INJECTION POLYURETHANE THERMOSET.

The belt thickness must be (5- 8mm). Colour: black

The table board shall be fixed on the metal framework using galvanized metalscrews, (3.5) cm.

Number of screws: 12. It should be fixed from the bottom.

-Raw materials should be flexible.

-The polyethylene materials should not be used due to harmful material.

-The materials that will be used for manufacturing are similar to these used globally for manufacturing food containers, which means it is safe to be used

-The used dyes and raw materials should be free of any cancerous materials.

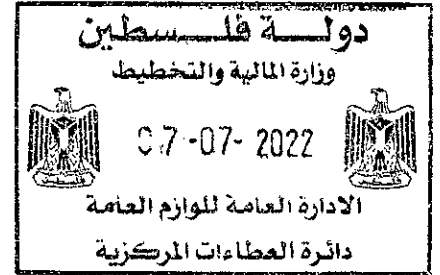

-Strength for the disk top should be high "not less than 250 kg".

3. Painting

- All metal shall be painted after applying anticorrosive treatment with at least three stages and cleaned from oil, grease, dust, and other dirt using special thermal control painting for metal furniture to form a layer of base painting of (iron phosphate) (0.4 – 0.8) gm/m².
 - Automatic spray painting shall be applied to be followed by a drying process in a thermal furnace with suitable temperature and time for the process.
 - Thickness of painting (60 – 80) micron.
 - (Aboxpolyster powder) paint should be used, colour: Marengo No. 7016
- Painting of iron, assembly, delivery and storage must be carried out away from climatic influence i.e. sun, dust etc.

4. Marking of goods:

The supplier shall put his commercial mark on all supplied pieces of goods by stamp or by fixing a sticker properly –approved by the Ministry- on the bottom face of the goods, this mark shall contain the name of the factory, tender No. and the financial resource, in a clear and permanent manner and approved by Ministry.

5. Packing:

The supplied goods shall be backed by using special plastic sheets (with air babbles) to prevent scratching of paintings and surfaces of goods .

6. Inspections and tests:

The MEHE has the right to test sample of this item at specialized labs or institutions at the Palestinian Authority area or nearby countries, at the supplier's expenses before and /or after bid award.



Student Desk 5

A. General

For 2 pupils.

B. Technical Specifications

Height, 70 cm

Dimension of table board: 45 x 115 cm

Thickness of table board: 17mm

Dimension of metal tubes: 20 x 20 mm & 40 x 20 mm

Thickness of metal sheets forming the metal tube: 1.25 mm

Color of the surface of table board (Formica): beige (cream) (3231)



1. Metal framework

The metal frame shall be made from hollow metal profile tubes (profilstahl).

Dimensions: 20 x 20 mm and 40 x 20 mm, thickness: 1.25 mm.

All metal pieces shall be welded together properly, strongly and in conformity with regulations.

CO2 welding shall be used.

Additional holes in the metal framework shall be made besides and equal in number to the existing holes to enable future maintenance.

All ends of the metal squares must be covered with black plastic covers.

Plastic heels are to be installed under the legs to elevate the iron parts from the ground and must be fixed with metal screws.

Two bag-holders should be fixed on each side of table.

2. Table board

The table board shall be made of pre-cut plywood (SANDWICH), best quality.

Thickness of table board shall be 17 mm, dimensions: 115 x 45 cm. It shall be covered with colored plastic FORMICA on both sides.

Top Formica thickness: 0.8mm. Color: beige (cream) (3231).

Bottom Formica thickness: 0.5mm.

The table board shall be belted using INJECTION POLYURETHANE THERMOSET.

The belt thickness must be (5- 8mm). Colour: black

The table board shall be fixed on the metal framework using galvanized metal screws, (3.5) cm.

Number of screws: 12. It should be fixed from the bottom.

-Raw materials should be flexible.

-The polyethylene materials should not be used due to harmful material.

-The materials that will be used for manufacturing are similar to those used globally for manufacturing food containers, which means it is safe to be used

-The used dyes and raw materials should be free of any cancerous materials.

-Strength for the disk top should be high "not less than 250 kg".

3. Painting

- All metal shall be painted after applying anticorrosive treatment with at least three stages and cleaned from oil, grease, dust, and other dirt using special thermal control painting for metal furniture to form a layer of base painting of (iron phosphate) (0.4 – 0.8) gm/m².
 - Automatic spray painting shall be applied to be followed by a drying process in a thermal furnace with suitable temperature and time for the process.
 - Thickness of painting (60 – 80) micron.
 - (Aboxpolyster powder) paint should be used, colour: Marengo No. 7016
- Painting of iron, assembly, delivery and storage must be carried out away from climatic influence i.e. sun, dust etc.

4. Marking of goods:

The supplier shall put his commercial mark on all supplied pieces of goods by stamp or by fixing a sticker properly –approved by the Ministry- on the bottom face of the goods, this mark shall contain the name of the factory, tender No. and the financial resource, in a clear and permanent manner and approved by Ministry.

5. Packing:

The supplied goods shall be backed by using special plastic sheets (with air babbles) to prevent scratching of paintings and surfaces of goods .

6. Inspections and tests:

The MEHE has the right to test sample of this item at specialized labs or institutions at the Palestinian Authority area or nearby countries, at the supplier's expenses before and /or after bid award.



Student Desk 6

A. General

For 2 pupils.

B. Technical Specifications

Height, 76 cm

Dimension of table board: 45 x 115 cm

Thickness of table board: 17mm

Dimension of metal tubes: 20 x 20 mm & 40 x 20 mm

Thickness of metal sheets forming the metal tube: 1.25 mm

Colour of the surface of table board (Formica): grey (3130)

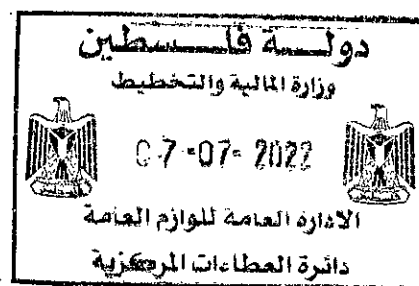

1. Metal framework

The metal frame shall be made from hollow metal profile tubes.

Dimensions: 20 x 20 mm and 40 x 20 mm, thickness: 1.25 mm.

All metal pieces shall be welded together properly, strongly and in conformity with regulations.

CO2 welding shall be used.

Additional holes in the metal framework shall be made besides and equal in number to the existing holes to enable future maintenance.

All ends of the metal squares must be covered with black plastic covers.

Plastic heels are to be installed under the legs to elevate the iron parts from the ground and must be fixed with metal screws.

Two bag-holders should be fixed on each side of table

2. Table board

The table board shall be made of precut plywood (SANDWICH), best quality.

Thickness of table board shall be 17 mm, dimensions: 115 x 45 cm. It shall be covered with colored plastic FORMICA on both sides.

Top Formica thickness: 0.8mm. Colour: grey (3130).

Bottom Formica thickness: 0.5mm.

The table board shall be belted using INJECTION POLYURETHANE THERMOSET.

The belt thickness must be (5- 8mm). Colour: black

The table board shall be fixed on the metal framework using galvanized metal screws (3.5) cm.

Number of screws: 12. It should be fixed from the bottom.

-Raw materials should be flexible.

-The polyethylene materials should not be used due to harmful material.

-The materials that will be used for manufacturing are similar to these used

globally for manufacturing food containers, which means it is safe to be used.

-The used dyes and raw materials should be free of any cancerous materials.

-Strength for the disk top should be high "not less than 250 kg".

3. Painting

- All metal shall be painted after applying anticorrosive treatment with at least three stages and cleaned from oil, grease, dust, and other dirt using special thermal control painting for metal furniture to form a layer of base painting of (iron phosphate) (0.4 – 0.8) gm/m².

- Automatic spray painting shall be applied to be followed by a drying process in a thermal furnace with suitable temperature and time for the process.

- Thickness of painting (60 – 80) micron.

- (Aboxpolyster powder) paint should be used, colour: Marengo No. 7016

Painting of iron, assembly, delivery and storage must be carried out away from climatic influence i.e. sun, dust etc.

4. Marking of goods:

The supplier shall put his commercial mark on all supplied pieces of goods by stamp or by fixing a sticker properly –approved by the Ministry- on the bottom face of the goods, this mark shall contain the name of the factory, tender No. and the financial resource, in a clear and permanent manner and approved by Ministry.

5. Packing:

The supplied goods shall be backed by using special plastic sheets (with air babbles) to prevent scratching of paintings and surfaces of goods .

6. Inspections and tests:

The MEHE has the right to test sample of this item at specialized labs or institutions at the Palestinian Authority area or nearby countries, at the supplier's expenses before and /or after bid award.



Student Desk

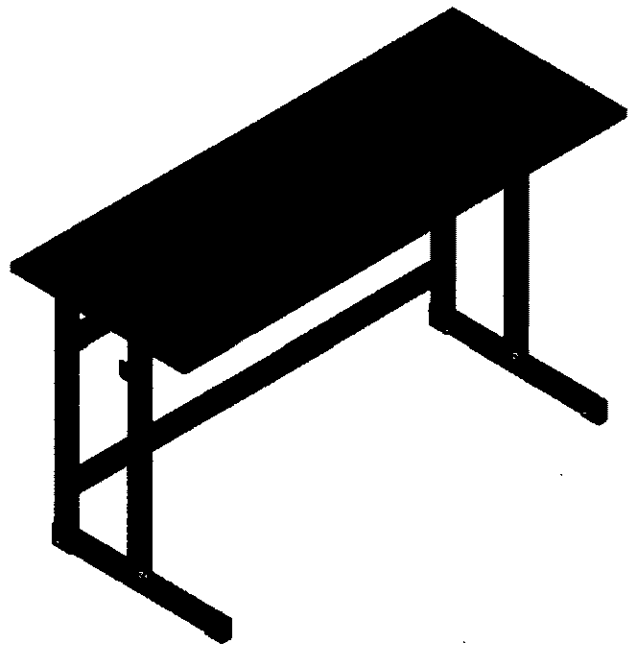
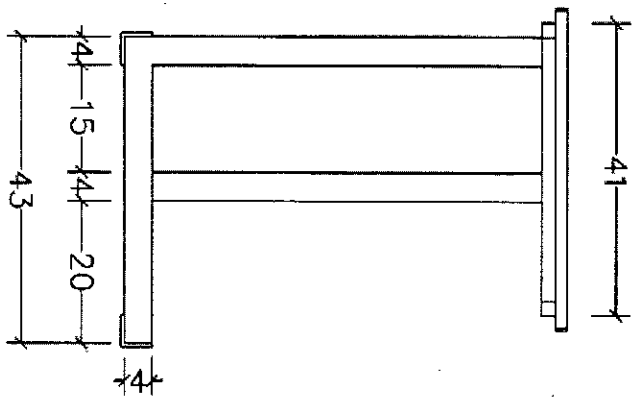
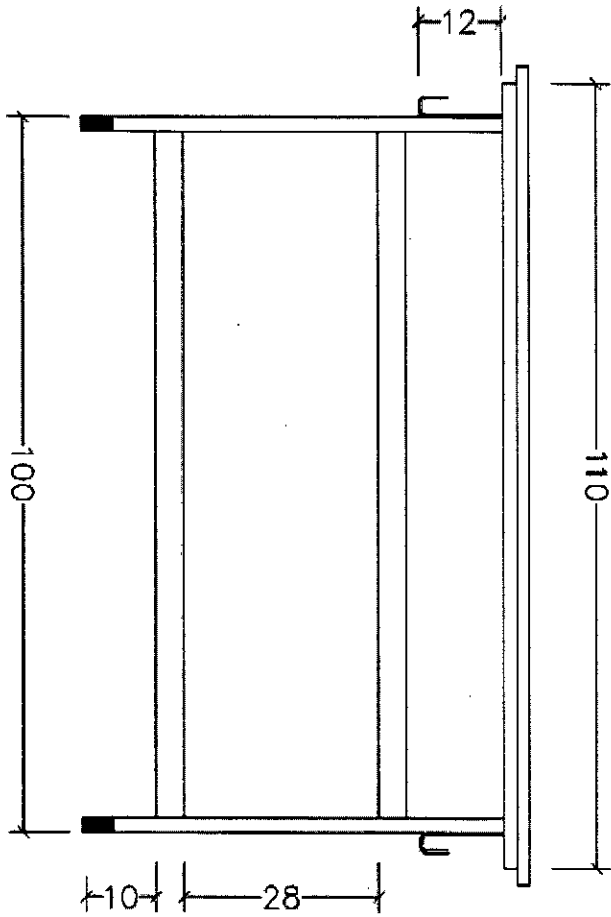

Student Desk

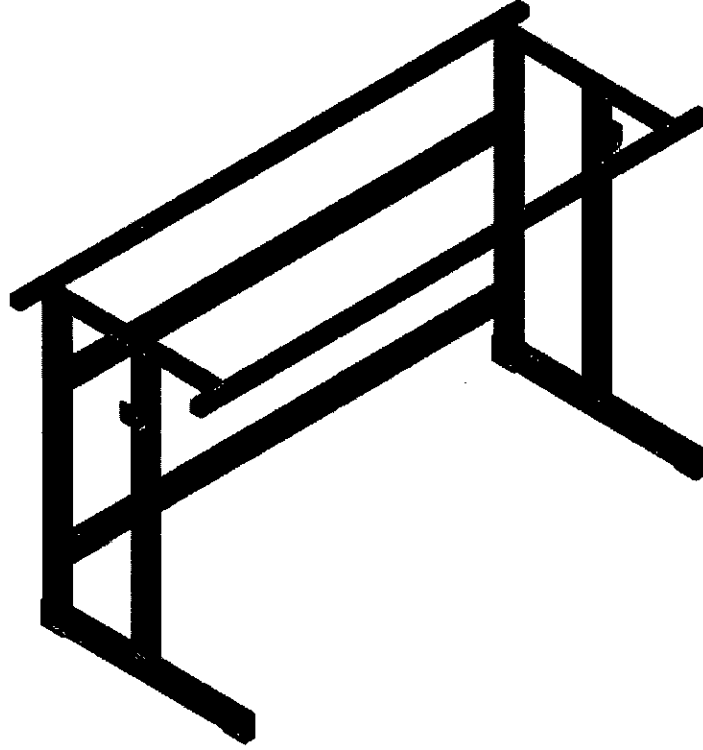

Student Chair 4

A. General

For 1 pupil

B. Technical Specifications

Height: 38 cm

Dimension of plastic seat: 33.5 x 34.5 cm

Dimension of plastic back: 19.5 x 34.5 cm

Plastic thickness: 5 - 8 mm

Plastic colour: grey

Diameter of iron pipes: 22 mm, 10/20mm

Thickness of iron pipes: 1.5 mm, 1.25mm

Width of chair: 40 cm

Note: for plastic dimensions measured by cms (± 0.5) cm



1. Metal framework

The metal framework shall be made from metal pipes. Diameter: 22 mm, thickness 1.5 mm.

The lateral metal connections shall be made of elliptical profile 10/20 mm with a thickness of 1.25mm.

All ends of metal pipes should be closed with plastic covers.

Plastic heels are to be installed at the bottom of the chair's legs.

All metal pieces shall be welded together properly, strongly and in conformity with regulations.

CO2 welding shall be used

2. Chair back and seat

- (Samples are available for bidders, to manufacture plastic parts with same chemical composition, same hardness, shape and thickness)
- Chair back and seat shall be made out of reinforced plastic. Thickness: 5-8mm.
- The chair back shall be fixed by metal screw; length 1.5cm, required number: 4.
- It shall be fixed from the backside.
- The seat shall be fixed by metal screw; length: 1.5 cm required number: 4.
- Strength for the plastic material of chair parts shall be according to international standards for this product .
- High flexibility for shocks resistant according to international standards for this product.
- Safe material for human touching that does not contain any mercury, lead, or any other harming materials.
- Made of first class raw materials, non recycled, and free of any cancerous materials.
- Resistant to direct sunlight for more than 4 years.

3. Painting

- All metal shall be painted after applying anticorrosive treatment with at least three stages and cleaned from oil, grease, dust, and other dirt using special thermal control painting for metal furniture to form a layer of base painting of (iron phosphate) (0.4 – 0.8) gm/m².
 - Automatic spray painting shall be applied to be followed by a drying process in a thermal furnace with suitable temperature and time for the process.
 - Thickness of painting (60 – 80) micron.
 - (Aboxpolyster powder) paint should be used, colour: Marengo No. 7016
- Painting of iron, assembly, delivery and storage must be carried out away from climatic influence i.e. sun, dust etc.

4. Marking of goods:

- a. The supplier shall put his commercial mark on all supplied pieces of goods by stamp or by fixing a sticker properly –approved by the Ministry- on the bottom face of the goods, this mark shall contain the name of the factory, tender No. and the financial resource, in a clear and permanent manner and approved by Ministry.
- b. Plastic parts of student and teacher chairs shall be marked thermally by sign (factory name) built in the template , approved by Ministry .

5. Packing:

The supplied goods shall be backed by using special plastic sheets (with air babbles) to prevent scratching of paintings and surfaces of goods .

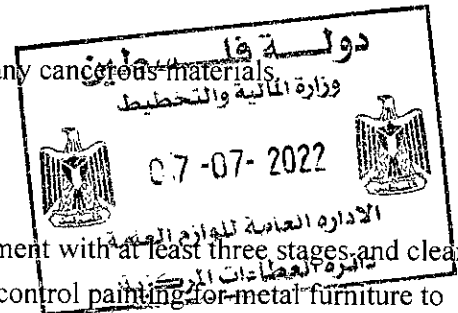

6. Inspections and tests:

The MEHE has the right to test sample of this item at specialized labs or institutions at the Palestinian Authority area or nearby countries, at the supplier's expenses before and /or after bid award.



Student Chair 5

A. General

For 1 pupil

B. Technical Specifications

Height: 42 cm

Dimension of plastic seat: 33.5 x 34.5 cm

Dimension of plastic back: 19.5 x 34.5 cm

Plastic thickness: 5 - 8 mm

Plastic colour: beige (cream)

Diameter of iron pipes: 22 mm, 10/20mm

Thickness of iron pipes: 1.5 mm, 1.25mm

Width of chair: 40 cm

Note: for plastic dimensions measured by cms (± 0.5) cm



1. Metal framework

The metal framework shall be made from metal pipes. Diameter: 22 mm, thickness 1.5 mm.

The lateral metal connections shall be made of elliptical profile 10/20 mm with a thickness of 1.25mm.

All ends of metal pipes should be closed with plastic covers.

Plastic heels are to be installed at the bottom of the chair's legs.

All metal pieces shall be welded together properly, strongly and in conformity with regulations.

CO2 welding shall be used

2. Chair back and seat

-(Samples are available for bidders, to manufacture plastic parts with same chemical composition, same hardness, shape and thickness)

-Chair back and seat shall be made out of reinforced plastic. Thickness: 5-8mm.

-The chair back shall be fixed by metal screw; length 1.5cm, required number: 4.

- It shall be fixed from the backside.

- The seat shall be fixed by metal screw; length: 1.5 cm required number: 4.

- Strength for the plastic material of chair parts shall be according to international standards for this product .

-High flexibility for shocks resistant according to international standards for this product.

-Safe material for human touching that does not contain any mercury, lead, or any other harming materials.

-Made of first class raw materials, non recycled, and free of any cancerous materials.

-Resistant to direct sunlight for more than 4 years.

3. Painting

- All metal shall be painted after applying anticorrosive treatment with at least three stages and cleaned from oil, grease, dust, and other dirt using special thermal control painting for metal furniture to form a layer of base painting of (iron phosphate) (0.4 – 0.8) gm/m².
 - Automatic spray painting shall be applied to be followed by a drying process in a thermal furnace with suitable temperature and time for the process.
 - Thickness of painting (60 – 80) micron.
 - (Aboxpolyster powder) paint should be used, colour: Marengo No. 7016
- Painting of iron, assembly, delivery and storage must be carried out away from climatic influence i.e. sun, dust etc.

4. Marking of goods:

- a. The supplier shall put his commercial mark on all supplied pieces of goods by stamp or by fixing a sticker properly –approved by the Ministry- on the bottom face of the goods, this mark shall contain the name of the factory, tender No. and the financial resource, in a clear and permanent manner and approved by Ministry.
- b. Plastic parts of student and teacher chairs shall be marked thermally by sign (factory name) built in the template , approved by Ministry .

5. Packing:

The supplied goods shall be backed by using special plastic sheets (with air babbles) to prevent scratching of paintings and surfaces of goods .

6. Inspections and tests:

The MEHE has the right to test sample of this item at specialized labs or institutions at the Palestinian Authority area or nearby countries, at the supplier's expenses before and /or after bid award.



Student Chair 6

A. General

For 1 pupil

B. Technical Specifications

Height: 46 cm

Width: 44 cm

Dimension of plastic seat: 37 x 37 cm

Dimension of plastic back: 22.5 x 37.5 cm

Plastic thickness: 5 - 8 mm

Plastic colour: grey

Diameter of iron pipes: 22 mm, 10/20mm

Thickness of iron pipes: 1.5 mm, 1.25mm

Width of chair: 44 cm

Note: for plastic dimensions measured by cms (± 0.5) cm



1. Metal framework

The metal framework shall be made from metal pipes. Diameter: 22 mm, thickness 1.5 mm.

The lateral metal connections shall be made of elliptical profile 10/20 mm with a thickness of 1.25mm.

All ends of metal pipes should be closed with plastic covers.

Plastic heels are to be installed at the bottom of the chair's legs.

All metal pieces shall be welded together properly, strongly and in conformity with regulations.

CO2 welding shall be used

2. Chair back and seat

-(Samples are available for bidders, to manufacture plastic parts with same chemical composition, same hardness, shape and thickness)

-Chair back and seat shall be made out of reinforced plastic. Thickness: 5-8mm.

-The chair back shall be fixed by metal screw; length 1.5cm, required number: 4.

- It shall be fixed from the backside.

- The seat shall be fixed by metal screw; length: 1.5 cm required number: 4.

- Strength for the plastic material of chair parts shall be according to international standards for this product .

-High flexibility for shocks resistant according to international standards for this product.

-Safe material for human touching that does not contain any mercury, lead, or any other harming materials.

-Made of first class raw materials, non recycled, and free of any cancerous materials.

-Resistant to direct sunlight for more than 4 years.

3. Painting

- All metal shall be painted after applying anticorrosive treatment with at least three stages and cleaned from oil, grease, dust, and other dirt using special thermal control painting for metal furniture to form a layer of base painting of (iron phosphate) (0.4 – 0.8) gm/m².
 - Automatic spray painting shall be applied to be followed by a drying process in a thermal furnace with suitable temperature and time for the process.
 - Thickness of painting (60 – 80) micron.
 - (Aboxpolyster powder) paint should be used, color: Marengo No. 7016
- Painting of iron, assembly, delivery and storage must be carried out away from climatic influence i.e. sun, dust etc.

4. Marking of goods:

- a. The supplier shall put his commercial mark on all supplied pieces of goods by stamp or by fixing a sticker properly –approved by the Ministry- on the bottom face of the goods, this mark shall contain the name of the factory, tender No. and the financial resource, in a clear and permanent manner and approved by Ministry.
- b. Plastic parts of student and teacher chairs shall be marked thermally by sign (factory name) built in the template , approved by Ministry .

5. Packing:

The supplied goods shall be backed by using special plastic sheets (with air babbles) to prevent scratching of paintings and surfaces of goods .

6. Inspections and tests:

The MEHE has the right to test sample of this item at specialized labs or institutions at the Palestinian Authority area or nearby countries, at the supplier's expenses before and /or after bid award.



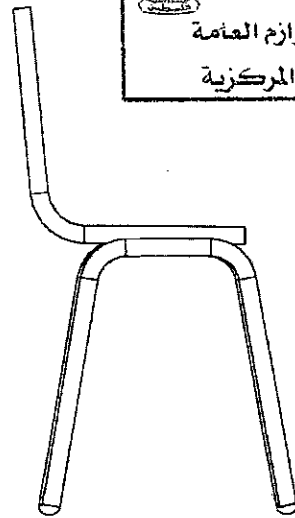
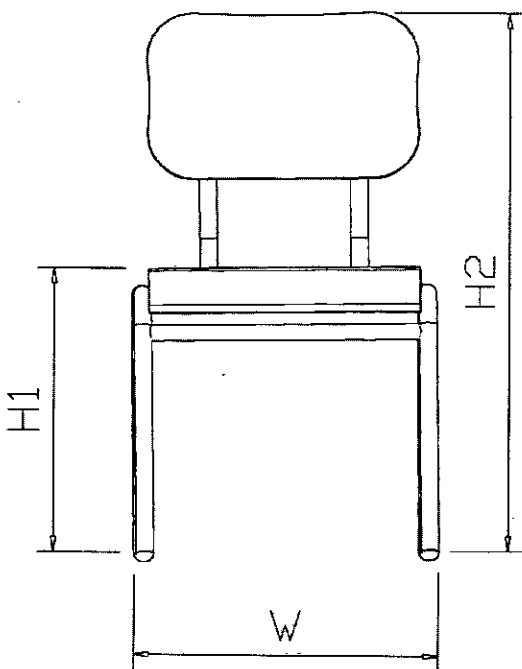
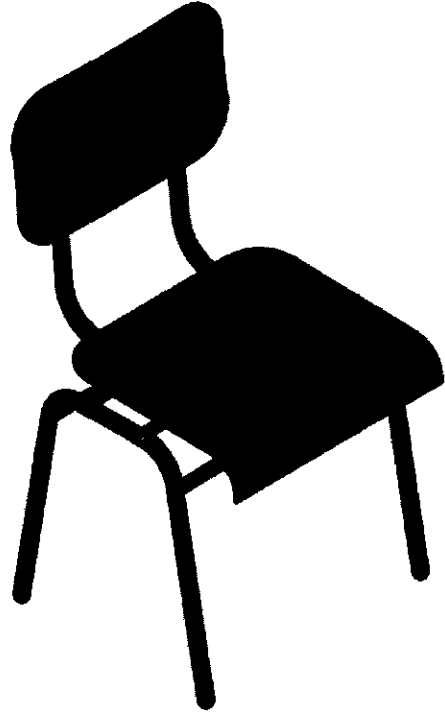
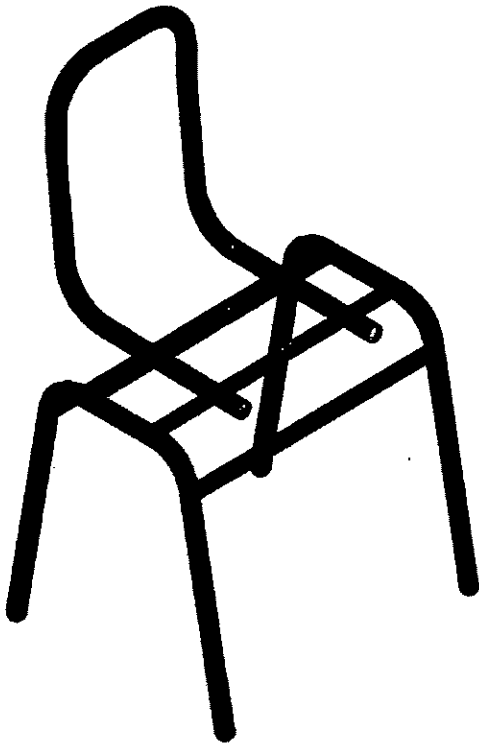

Headmaster/Officer Desk



A. General

Dimensions: 150x70x75H

B. Technical Specifications

Shape dimensions as attached figure

Both sides of the desk, should be made of (MDF) of best quality and with thickness of 28 mm.

Top board of the desk (face) shall be made of (MDF) of best quality with thickness of 28 mm. with rounded as a 1/2 circle for two long edges, the four edges shell be painted with at least 3 layers of base and transparent lacquer paint, as shown on attached figure.

The front panel, drawers and the compartment should be made of (MDF) of best quality, thickness (17mm).

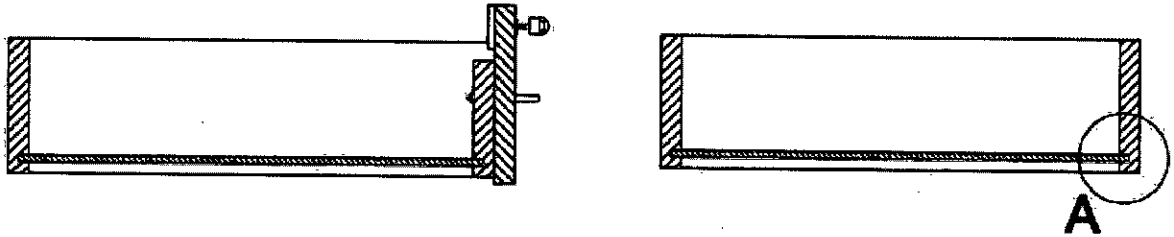

All parts of the desk shall be covered with a layer of melamine colour: Beech wood.

The desk shall contain a compartment unit at the left hand side and a drawer unit with three drawers at the right side.

Drawers and coup artment made of precut plywood (sandwich) thickness 17 mm best quality covered with a layer of melamine drawer base shall be fixed as shown in figure.

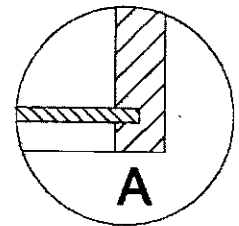

All edges should be covered by plastic belt, thickness (1.5-2mm), colour black.

Plastic heels shall be installed under the desk (quautity:4) as shown on figure (sample is available at MOE).

Knobs of good quality shall be installed on the compartment and drawers in a way allows for smooth opening and closing.

The side of the compartment shall be fixed with chromium plated metal hinges (Yugoslavian type) of best quality. (2 hinges)

The top drawer and the compartment shall have cylindrical locks of best quality.

The drawers shall slide on steel rails 1.25 mm thick with wheels to ensure smooth movement of the drawers.

All parts of the desk shall be assembled by using metal angles and galvanized metal screws, special for wooden furniture.

Type of locks for compartment and top drawers are from best quality approved by Ministry of Education.

C. Marking of goods:

The supplier shall put his commercial mark on all supplied pieces of goods by stamp or by fixing a sticker properly –approved by the Ministry- on the bottom face of the goods, this mark shall contain the name of the factory, tender No. and the financial resource, in a clear and permanent manner and approved by Ministry.

D. Packing:

a-It should be backed unassembled using special cardboard for this type of furniture.

b-The supplier shall assemble the furniture at his expenses and responsibility, at the assigned places according to distribution table.

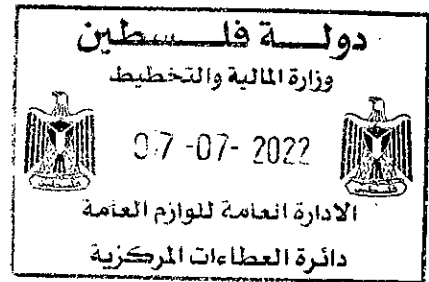

Headmaster/Officer Desk

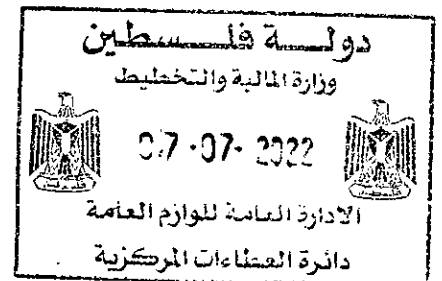
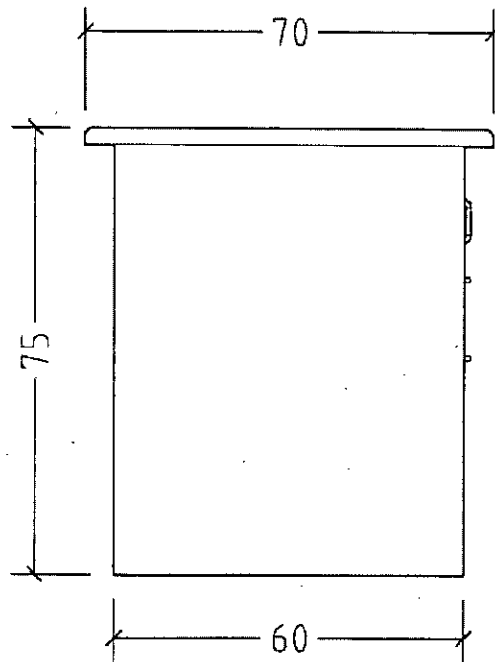
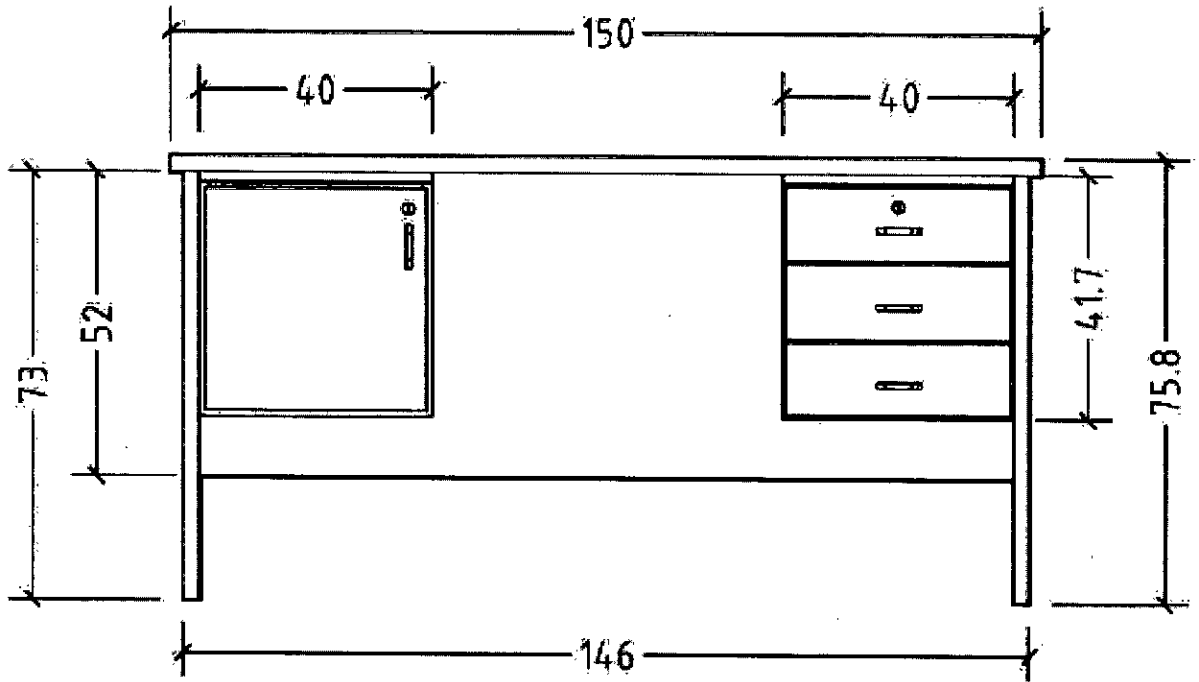

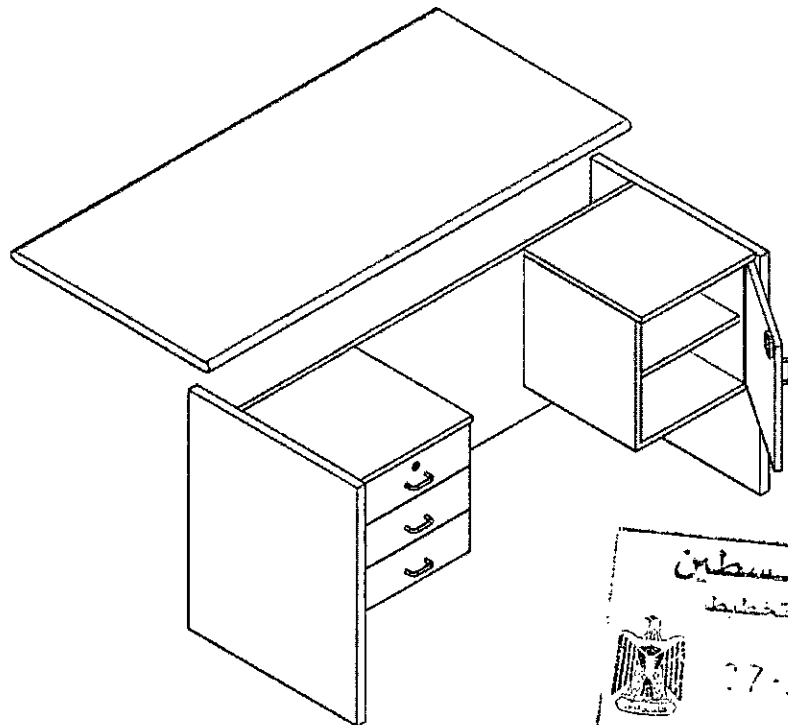
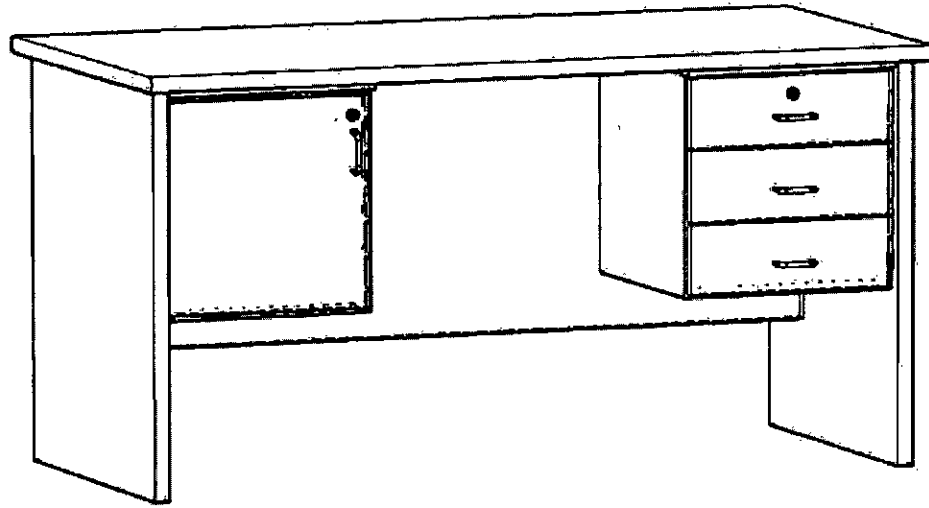

Officer Desk

A. General

Dimensions: 120x60x76H

B. Technical Specifications

Shape dimensions as off ached figure

Both sides of the desk, should be made of (MDF) of best quality and with thickness of 28 mm.

Top board of the desk (face) shall be made of (MDF) of best quality with thickness of 28 mm. with rounded as a ½ circle for two long edges the four edges shall be painted with at least 3 layers of base and transparent lacquer paint, as shown on attached figure.

The front panel and drawer faces shall be made of MDF of the best quality and thickness (17 mm).

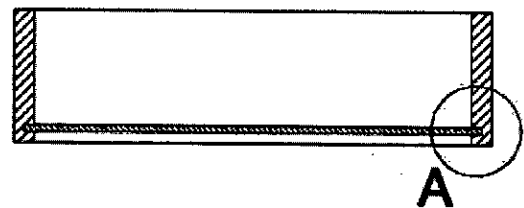
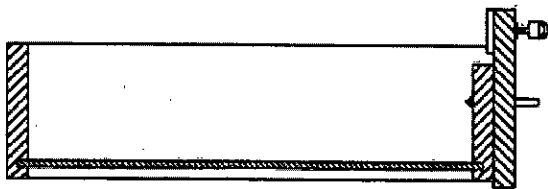
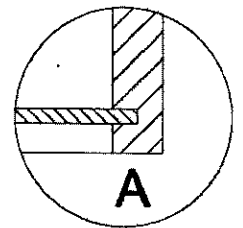

All parts of the desk shall be covered with a layer of melamine: Beech wood.

The desk should have a three-drawer unit on the right side.

Drawers made of precut plywood (sandwich) thickness 17 mm best quality covered with a layer of melamine drawer base shall be fixed as shown in figure.

All edges should be covered by plastic belt, thickness (1.5-2mm), colour black.

Plastic heels shall be installed under the desk (quantity:4) as shown on figure (sample is available at MOE).

The high-quality handles are mounted on the drawers in a way that allows for smooth opening and closing.

The upper drawer should have cylindrical locks of the best quality (approved by the Ministry of Education).

The drawers shall slide on steel rails 1.25 mm thick with wheels to ensure smooth movement of the drawers.

All parts of the desk shall be assembled by using metal angles and galvanized metal screws, special for wooden furniture.

C. Marking of goods:

The supplier shall put his commercial mark on all supplied pieces of goods by stamp or by fixing a sticker properly – approved by the Ministry- on the bottom face of the goods, this mark shall contain the name of the factory, tender No. and the financial resource, in a clear and permanent manner and approved by Ministry.

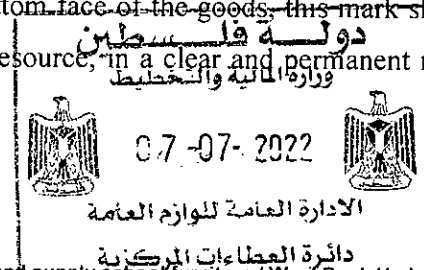

D. Packing:

a-It should be backed unassembled using special cardboard for this type of furniture.

b-The supplier shall assemble the furniture at his expenses and responsibility, at the assigned places according to distribution table.

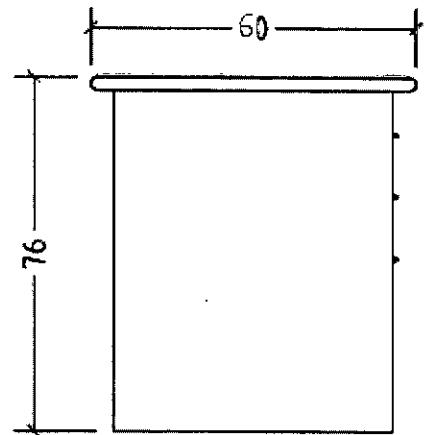
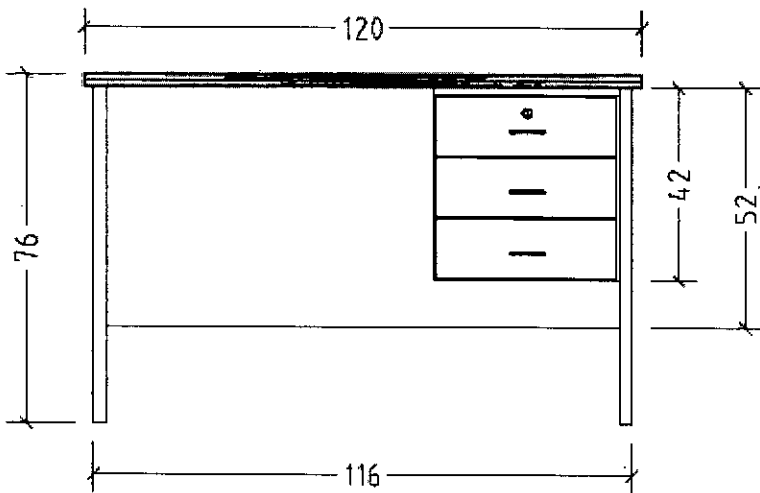
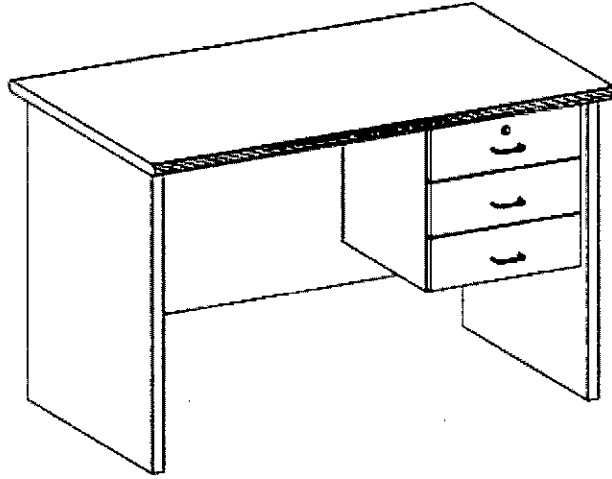

Wooden closet shelves with two bottom doors

A: General,

82x40x200 H

B: Technical specifications.

1. Shall be made as shown on attached figure.
2. Shall be made of (MDF) with a minimum thickness of 17mm, best quality.
3. Shelves shall be made of (MDF) with a minimum thickness of 28mm best quality.
4. all part of closet shall be covered with a layer of melamine colour: Beech wood.
5. all edges shall be covered with plastic belt, thickness (2) mm. colour: black.
6. Back of closet shall be covered with (mozanite), colour: white.
7. Two metallic handles shall be fixed on wooden doors.
8. A cylindrical lock of best quality shall be installed on wooden doors to be locked firmly.
9. All part of closet shall be assembled by using metal angles and galvanized metal screws special for wooden furniture.
10. Plastic angle heels are to be installed under the closet (quantity:4) to elevate the wooden parts from the ground.

C: Dimensions:

Length: 200 cm

Width: 82 cm

Depth: 40 cm

D. Marking of goods:

The supplier shall put his commercial mark on all supplied pieces of goods by stamp or by fixing a sticker properly –approved by the Ministry- on the bottom face of the goods, this mark shall contain the name of the factory, tender No. and the financial resource, in a clear and permanent manner and approved by Ministry.

E. Packing:

The supplied goods shall be backed by using special plastic sheets to prevent scratching of paintings and surfaces of goods .

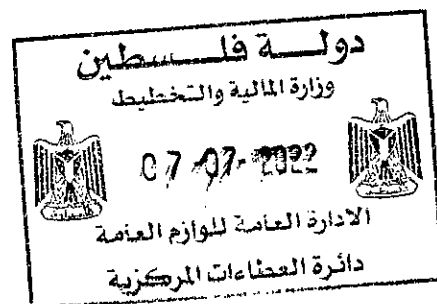

Wooden closet shelves with two bottom doors:

82x40x200 H

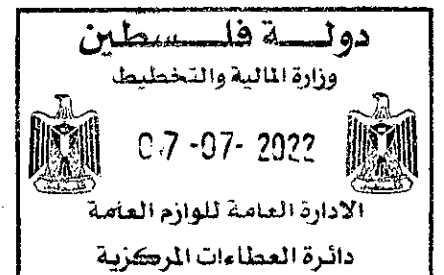
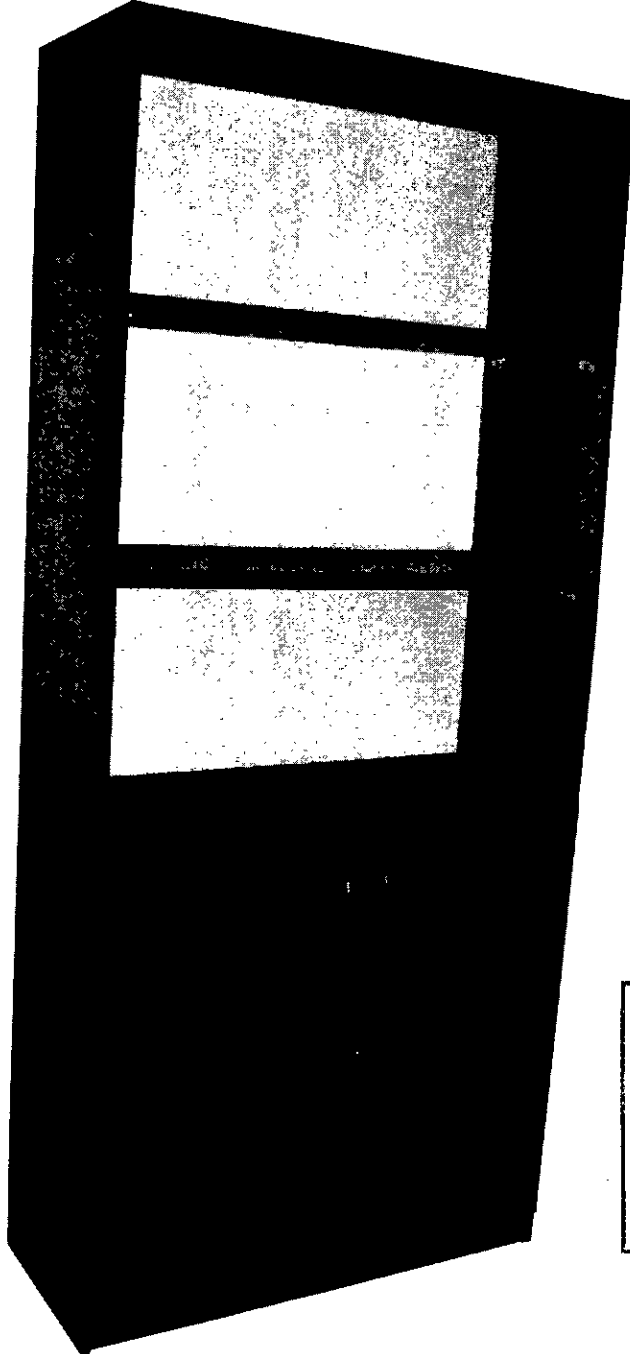

Teacher Desk (Classroom)

A. General

In class room use.

B. Technical Specifications

1. Metal framework

The metal framework shall be made of hollow metal profile tubes.

Dimensions: 20 x 20 mm and 40 x 20 mm, thickness: 1.25 mm.

All metal pieces shall be welded together properly, strongly and in conformity with regulations.

CO2 welding shall be applied.

Additional holes in the metal framework shall be made equal in number to the existing holes to enable future maintenance.

All ends of the iron squares must be closed with plastic covers.

Plastic heels are to be installed under the legs to elevate the iron parts from the ground and must be fixed with metal screws.

2. Table Board and Front Cover

The table board and front cover shall be made of precut plywood (SANDWICH), best quality.

Thickness of table board shall be 17 mm, dimensions: 110 x 54 cm. It shall be covered with coloured plastic FORMICA on both sides.

Top Formica thickness: 0.8mm. Colour: grey (3130).

Bottom Formica thickness: 0.5mm.

The table board shall be belted using INJECTION POLYURETHANE THERMOSET.

The belt thickness must be (5- 8mm). Colour: black

The table board and front cover shall be fixed on the metal frame using galvanized metal screws, (3.5) cm.

Number of screws:12 for each. It should be fixed from the bottom, and inside.

-Raw materials should be flexible.

-The polyethylene materials should not be used due to harmful material.

-The materials that will be used for manufacturing are similar to these used globally for manufacturing food containers, which means it is safe to be used.

-The used dyes and raw materials should be free of any cancerous materials.

-Strength for the disk top should be high "not less than 250 kg"

3. Painting

- All metal shall be painted after applying anticorrosive treatment with at least three stages and cleaned from oil, grease, dust, and other dirt using special thermal control painting for metal furniture to form a layer of base painting of (iron phosphate) (0.4 – 0.8) gm/m².

- Automatic spray painting shall be applied to be followed by a drying process in a thermal furnace with suitable temperature and time for the process.

- Thickness of painting (60 – 80) micron.

- (Aboxpolyster powder) paint should be used, colour: Marengo No. 7016



Painting of iron, assembly, delivery and storage must be carried out away from climatic influence
i.e. sun, dust etc.

4. Marking of goods:

a. The supplier shall put his commercial mark on all supplied pieces of goods by stamp or by fixing a sticker properly –approved by the Ministry- on the bottom face of the goods, this mark shall contain the name of the factory, tender No. and the financial resource, in a clear and permanent manner and approved by Ministry.

5. Packing:

The supplied goods shall be backed by using special plastic sheets (with air babbles) to prevent scratching of paintings and surfaces of goods .

6. Inspections and tests:

The MEHE has the right to test sample of this item at specialized labs or institutions at the Palestinian Authority area or nearby countries, at the supplier's expenses before and /or after bid award.

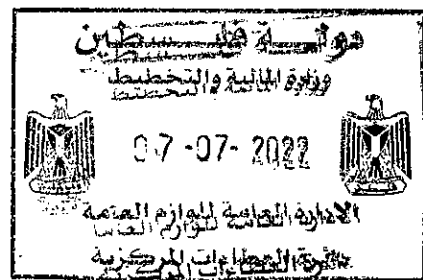

Teacher Desk (Classroom)

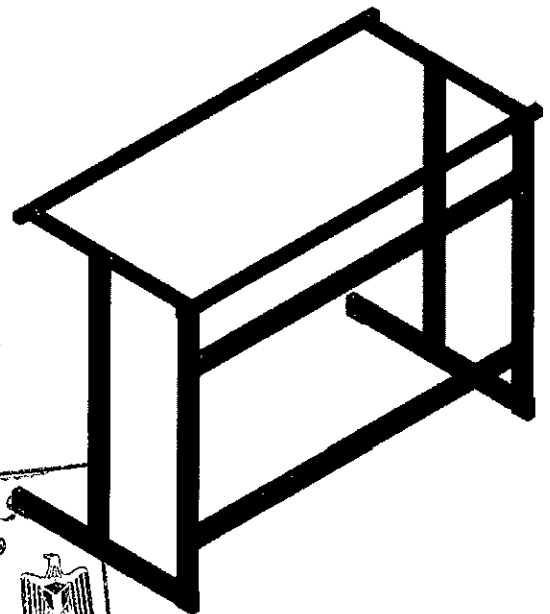
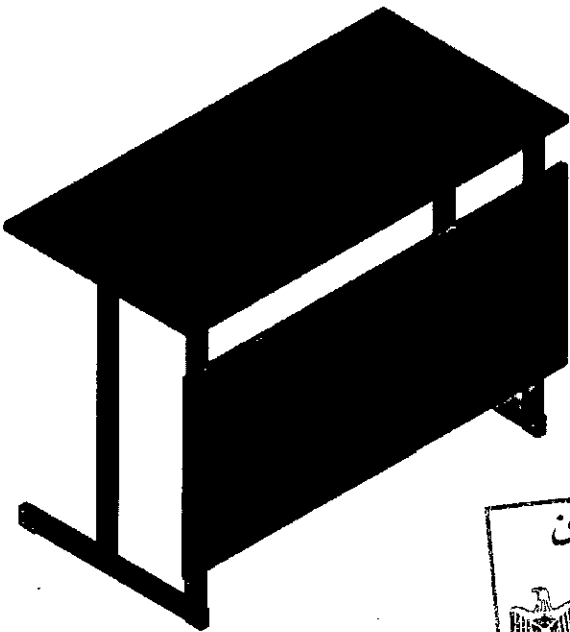
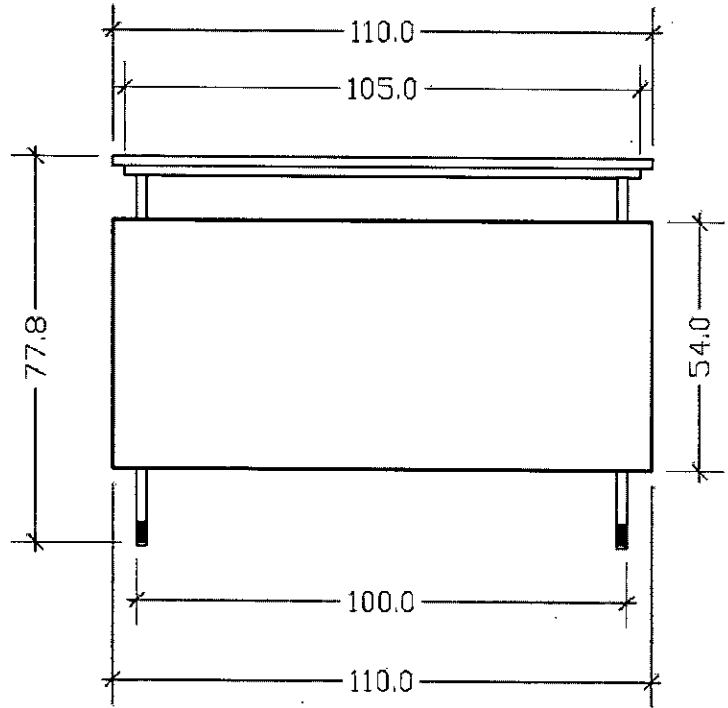
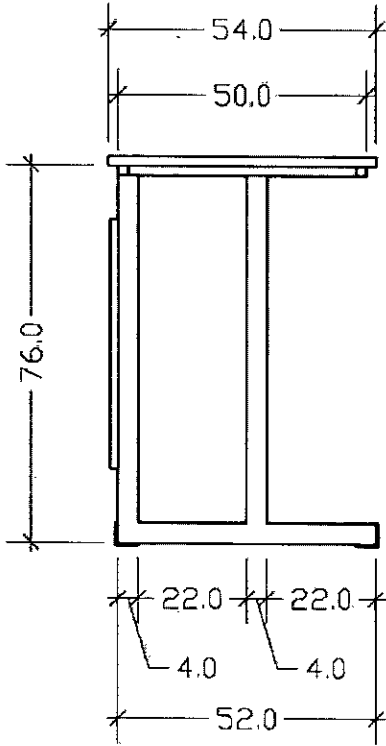

Metal File Cabinet (4 Drawers)

A. General

B. Technical Specifications

1. Metal framework

The metal framework shall be made of metal sheets 0.8 mm thick including the back.

All metal pieces are to be welded together properly, strongly and in conformity with regulations by using CO2 and point welding.

Plastic heels shall be installed at the bottom of the cabinet's legs.

A (U) shape horizontal divider between drawers is from metal sheets 0.8 mm thick shall be installed between drawers.

2. Dimensions

Length: 132.5 cm, Width: 46cm, Depth: 65 cm.

3. Internal division

Four drawers with the same size shall be installed with plastic rails and pulleys (Wheels) to ease opening and closing the drawers.

Each drawer shall have a plastic grip and a card index on the upper part.

A pressed lock shall be installed on the top to lock the cabinet.

Rails out of metal sheet shall be fixed on both sides; thickness: 1.25 mm for the drawers to slide on.

4. Painting

- All metal shall be painted after applying anticorrosive treatment with at least three stages and cleaned from oil, grease, dust, and other dirt using special thermal control painting for metal furniture to form a layer of base painting of (iron phosphate) (0.4 – 0.8) gm/m².
- Automatic spray painting shall be applied to be followed by a drying process in a thermal furnace with suitable temperature and time for the process.
- Thickness of painting (60 – 80) micron.
- (Epoxy polyester powder) paint should be used, colour :beige مبزر (3010) and brown مبزر (6418)

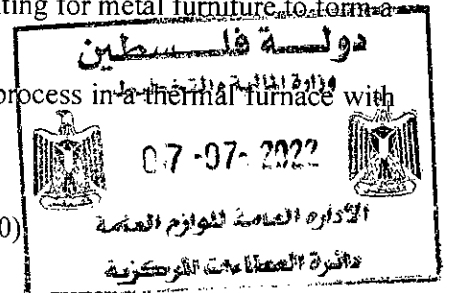

Painting of iron, assembly, delivery and storage must be carried out away from climatic influence i.e. sun, dust etc.

5. Marking of goods:

The supplier shall put his commercial mark on all supplied pieces of goods by stamp or by fixing a sticker properly –approved by the Ministry- on the bottom face of the goods, this mark shall contain the supplier name, tender No. and the financial resource, in a clear and permanent manner and approved by Ministry.

5. Packing:

The supplied goods shall be backed by using special plastic sheets or special card board to prevent scratching of paintings and surfaces of goods.

Metal File Cabinet (4 Drawers)

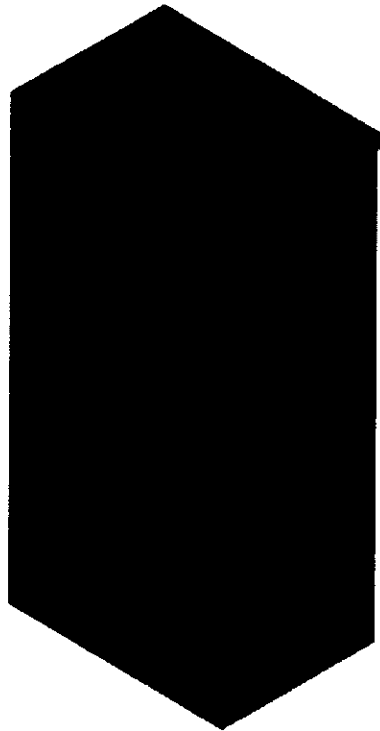
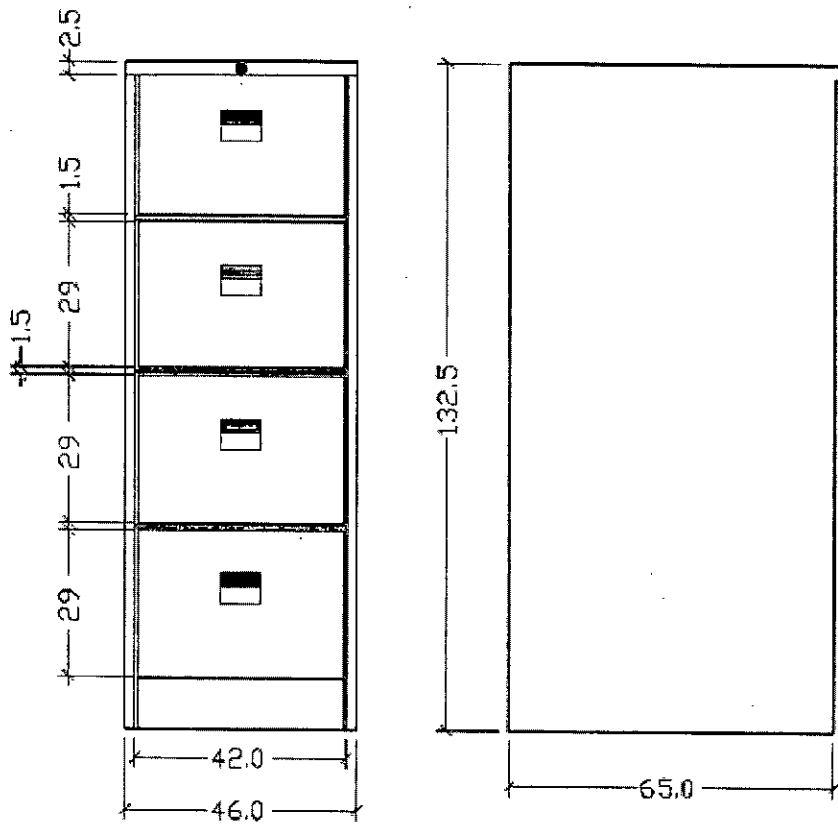

Reading Table

A. General

H=76 cm

B. Technical Specifications

1. Metal framework

The metal framework shall be made from square steel profile tubes 30 x 30 mm and 40 x 40 mm and 2 mm thick.

The bottom edge of the metal frame shall be covered with plastic heels.

All metal pieces are to be welded together properly, strongly and in conformity with regulations. CO2 welding shall be used.

Ten angles (20/20) mm. (5cm length) shall be fixed on top of framework to fix the table board.

Plastic heels are to be installed under the legs to elevate the iron parts from the ground.

2. Table board

The table board shall be made of plywood "sandwich" board, best quality.

Thickness of plywood is 17 mm. Dimensions: 180X80 cm

It shall be covered with stretched laminated plastic sheet (Formica MATT) 0.8 mm thick. Color gray (3130).

The table board shall be thickened by using strips of plywood (sandwich) wood 17 x 50 mm around the backside edges of the table's board.

Beech wood shall be used in belting the edges of the table board 15 mm thick and 34 mm wide.

The beech belt shall be painted with three coats of lacquer paint in addition to prime coat and to be fixed by using adhesive materials with no nailing. Fixing of the beech belt shall be done after the lamination with the plastic sheets.

The table board shall be fixed on the metal framework using metal screws (1.5cm).

3. Painting

- All metal shall be painted after applying anticorrosive treatment with at least three stages and cleaned from oil, grease, dust, and other dirt using special thermal control painting for metal furniture to form a layer of base painting of (iron phosphate) (0.4 – 0.8) gm/m².

- Automatic spray painting shall be applied to be followed by a drying process in a thermal furnace with suitable temperature and time for the process.

- Thickness of painting (60 – 80) micron.

- (Epoxy polyester powder) paint should be used, color: Marengo No. 7016. Painting of iron, assembly, delivery and storage must be carried out away from climatic influence i.e. sun, dust etc.

4. Marking of goods:

a. The supplier shall put his commercial mark on all supplied pieces of goods by stamp or by fixing a sticker properly –approved by the Ministry- on the bottom face of the goods, this mark shall contain the supplier name, tender No. and the financial resource, in a clear and permanent manner and approved by Ministry.

5. Packing:

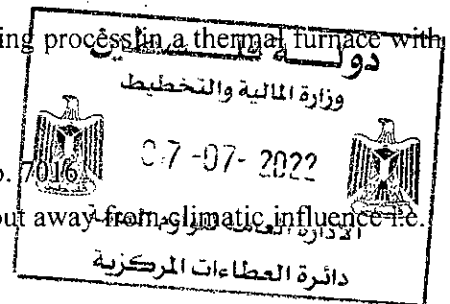

The supplied goods shall be backed by using special plastic sheets to prevent scratching of paintings and surfaces of goods .

Reading Table

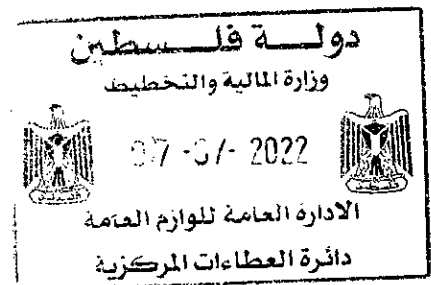
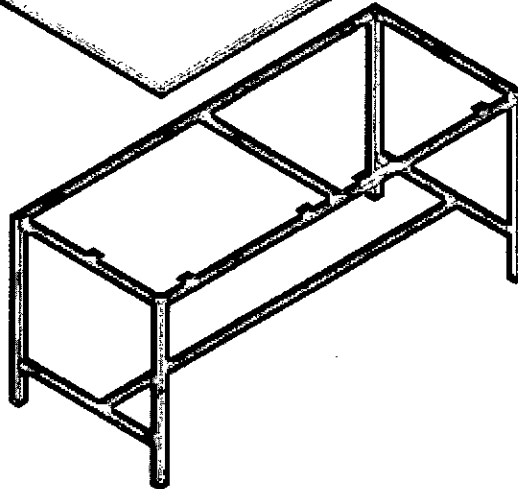
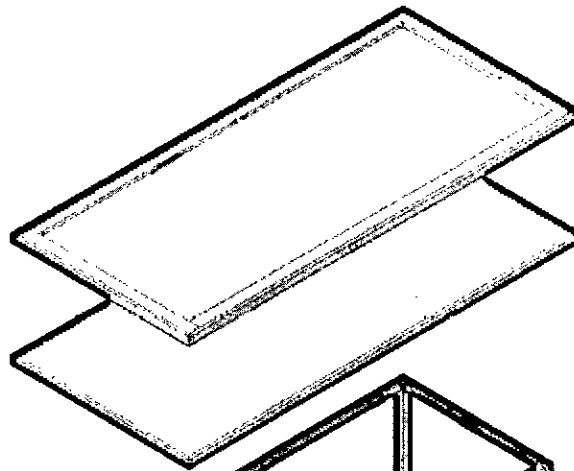
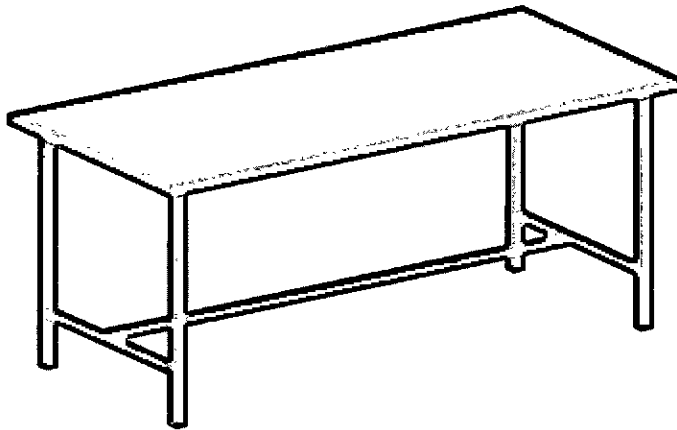

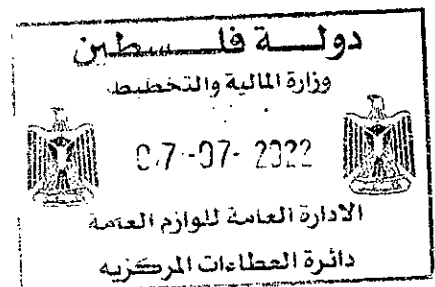
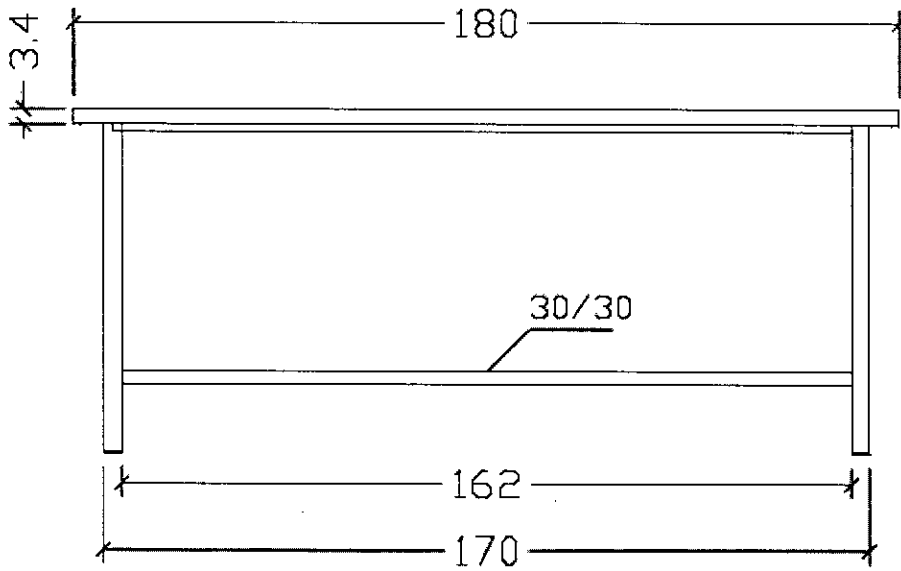
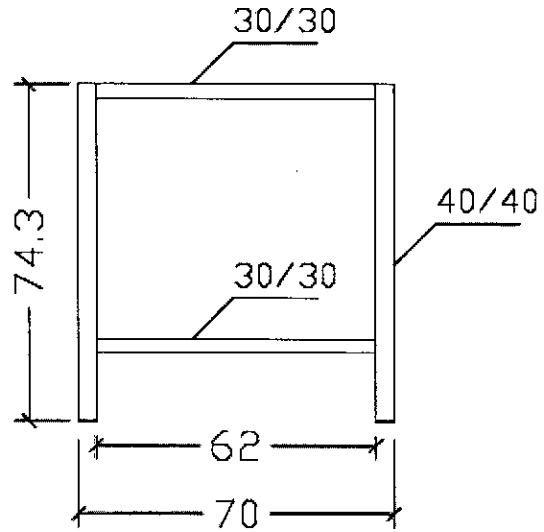
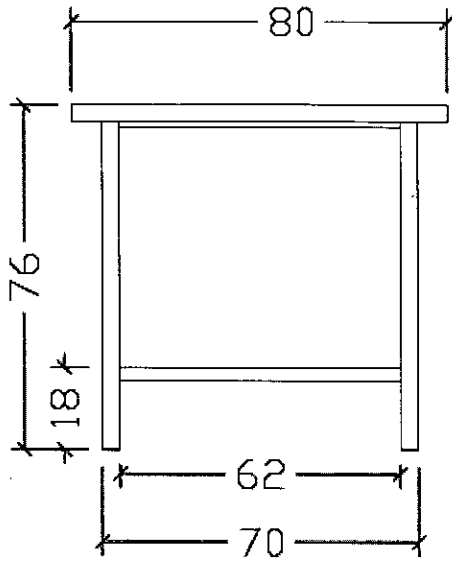

Bookshelf

A. General

90×30×200 H

B. Technical Specifications

- The bookshelves shall be made of plywood (sandwich board) with a minimum thickness of 17 mm, best quality.
- The back shall be covered with a plate made of mosonite wood 5 mm thick, color: white.
- The shelves which are made of plywood shall be fixed using glue and 4 cm long pins.
- Distance between shelves shall be equal.
- The wooden parts shall be covered with stretched laminating plastic sheet (Formica) 0.8 mm thick, best quality. Colour: grey (3130).
- All edges should be cover by hardened plastic belt thickness (1.5-2mm) colour: black.
- The back shall be fixed using metal screws 1.5 cm long.
- Plastic heels are to be installed under the legs to elevate the wooden parts from the ground.
- Dimensions: Length; 200 cm, Width; 90 cm, Depth 30 cm.

C. Marking of goods:

The supplier shall put his commercial mark on all supplied pieces of goods by stamp or by fixing a sticker properly –approved by the Ministry- on the bottom face of the goods, this mark shall contain the supplier name, tender No. and the financial resource, in a clear and permanent manner and approved by Ministry.

D. Packing:

The supplied goods shall be backed by using special plastic sheets to prevent scratching of paintings and surfaces of goods.

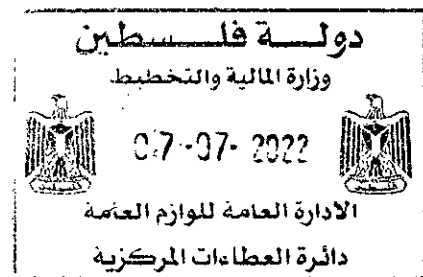

Bookshelf

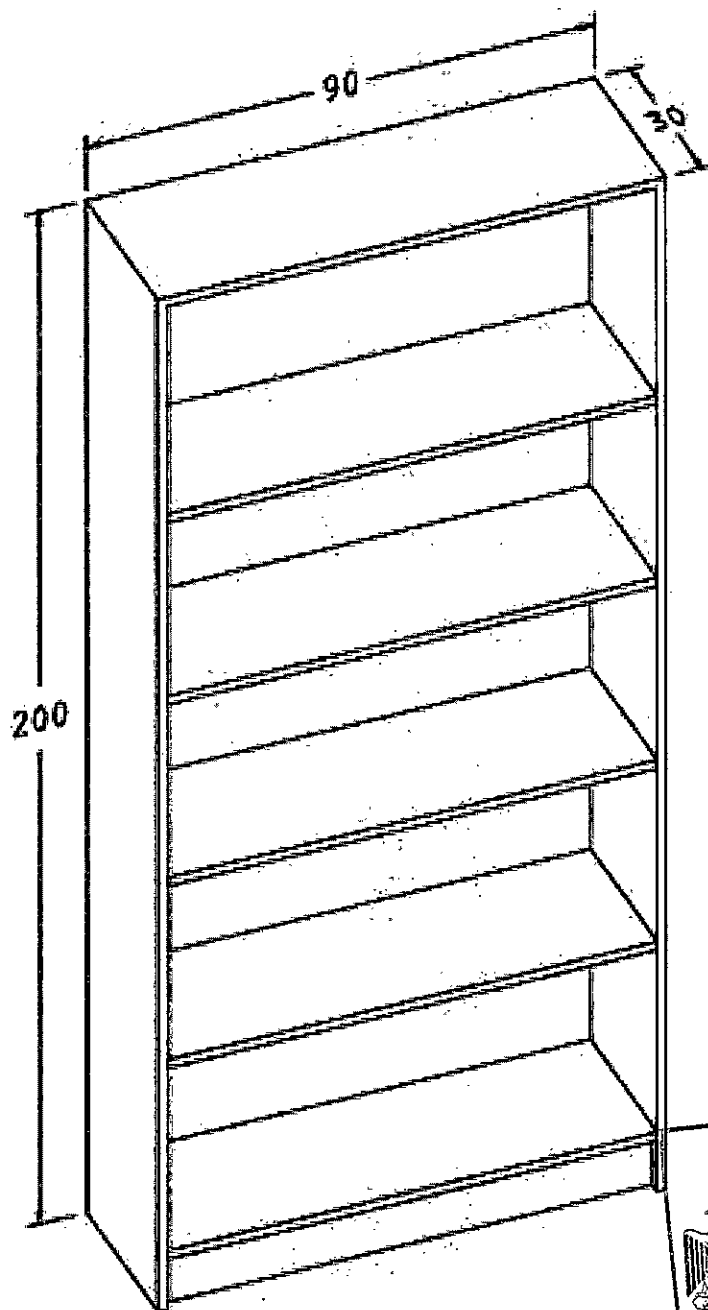

Multipurpose Chair

A. General

B. Technical Specifications

1. Metal framework

The metal framework shall be made from iron pipes painted by using electrostatic process.

Diameter: 25 mm, thickness: 2 mm.

Bending: as shown in the figure.

The metal ends shall be covered with plastic covers.

Plastic heels are to be installed under the chair.

2. Chair back and seat

Seat measurement: 50 x 45 cm approx.

Chair back measurements 50 x 22 cm approx.

The back and the seat shall be made of plywood (sandwich) with a minimum thickness of 17 mm, best quality.

The chair back and seat shall be upholstered press sponge (33/35).

The thickness of sponge for the chair back should not be less than 4 cm and for the seat 6 cm.

Special, good quality cloth shall be used for covering the chair back and seat.

The chair' seat and back shall be fixed using metal screws. Number of screws: 8.

3. Painting

- All metal shall be painted after applying anticorrosive treatment with at least three stages and cleaned from oil, grease, dust, and other dirt using special thermal control painting for metal furniture to form a layer of base painting of (iron phosphate) (0.4 – 0.8) gm/m².

- Automatic spray painting shall be applied to be followed by a drying process in a thermal furnace with suitable temperature and time for the process.

- Thickness of painting (60 – 80) micron.

- (Aboxpolyster powder) paint should be used, color: black

Painting of iron, assembly, delivery and storage must be carried out away from climatic influence i.e. sun, dust etc.

4. Marking of goods:

The supplier shall put his commercial mark on all supplied pieces of goods by stamp or by fixing a sticker properly –approved by the Ministry- on the bottom face of the goods, this mark shall contain the name of the factory, tender No. and the financial resource, in a clear and permanent manner and approved by Ministry.

5. Packing:

The supplied goods shall be backed by using special plastic sheets to prevent scratching of paintings and surfaces of goods.



Multipurpose Chair

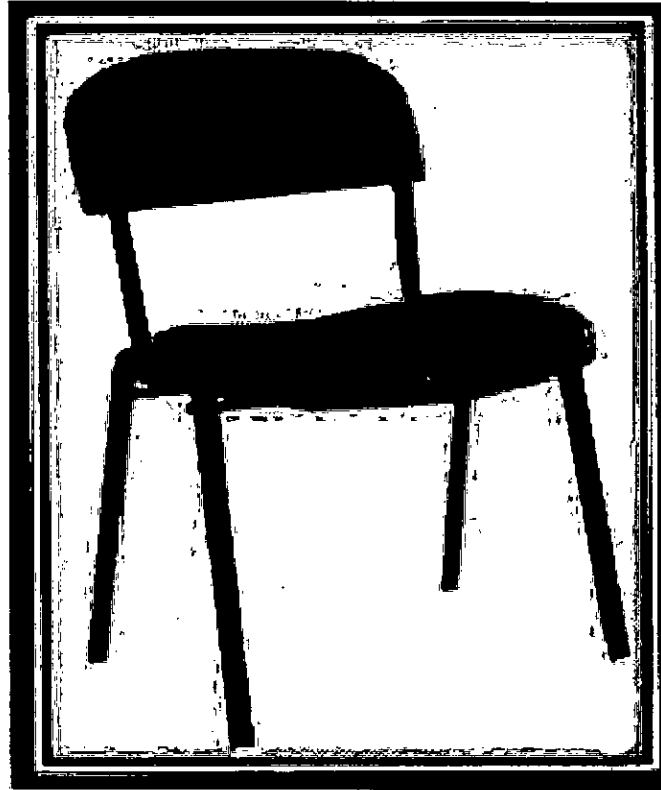

Working Table



A. General

H=86 cm

B. Technical Specifications

1. Metal framework

The metal framework shall be made from square steel profile tubes 30 x 30 mm and 40 x 40 mm and 1.25 mm thick.

The bottom edge of the metal frame shall be covered with plastic heels.

All metal pieces are to be welded together properly, strongly and in conformity with regulations.

All ends of the metal squares must be closed with black plastic covers.

CO2 welding shall be used.

Ten angles (20/20) mm. (5cm length) shall be fixed on top of framework to fix the table board.

Plastic heels are to be installed under the legs to elevate the iron parts from the ground.

2. Table board

The table board shall be made of plywood "sandwich" board, best quality.

Thickness of plywood is 34 mm, dimensions: 200 x 90 cm.

It shall be covered with stretched laminated plastic sheet (Formica) 0.8 mm thick. Colorgray (3130).

Beech wood shall be used in belting the edges of the table board 15 mm thick and 34 mm wide.

The beech belt shall be painted with three coats of lacquer paint in addition to prime coat and to be fixed by using adhesive materials with no nailing. Fixing of the beech belt shall be done after the lamination with the plastic sheets.

The table board shall be fixed on the metal framework using metal screws (3 cm).

Plastic sheet type is "MATT".

3. Painting

- All metal shall be painted after applying anticorrosive treatment with at least three stages and cleaned from oil, grease, dust, and other dirt using special thermal control painting for metal furniture to form a layer of base painting of (iron phosphate) (0.4 – 0.8) gm/m².
 - Automatic spray painting shall be applied to be followed by a drying process in a thermal furnace with suitable temperature and time for the process.
 - Thickness of painting (60 – 80) micron.
 - (Epoxy polyester powder) paint should be used, colour: Marengo No. 7016
- Painting of iron, assembly, delivery and storage must be carried out away from climatic influence i.e. sun, dust etc.

4. Marking of goods:

- a. The supplier shall put his commercial mark on all supplied pieces of goods by stamp or by fixing a sticker properly – approved by the Ministry- on the bottom face of the goods, this mark shall contain the supplier name, tender No. and the financial resource, in a clear and permanent manner and approved by Ministry.

5. Packing:

The supplied goods shall be backed by using special plastic sheets (with air babbles) to prevent scratching of paintings and surfaces of goods.



Working Table

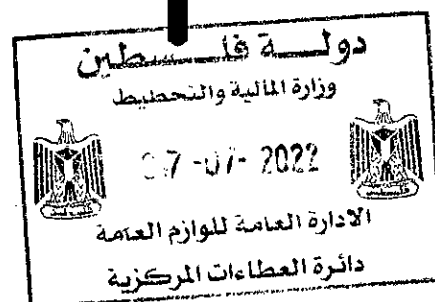
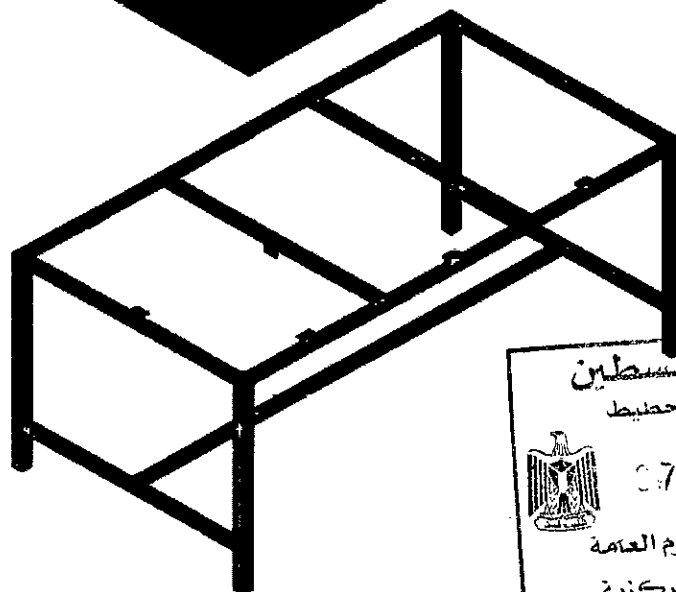
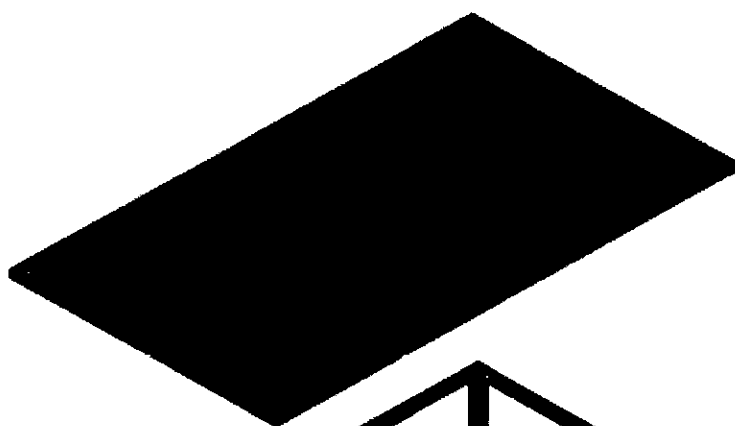
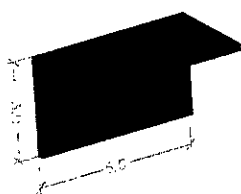
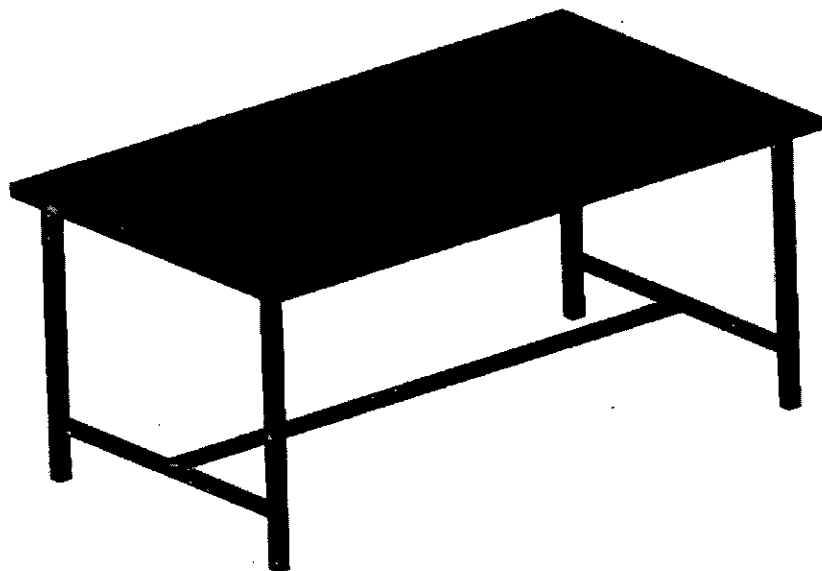

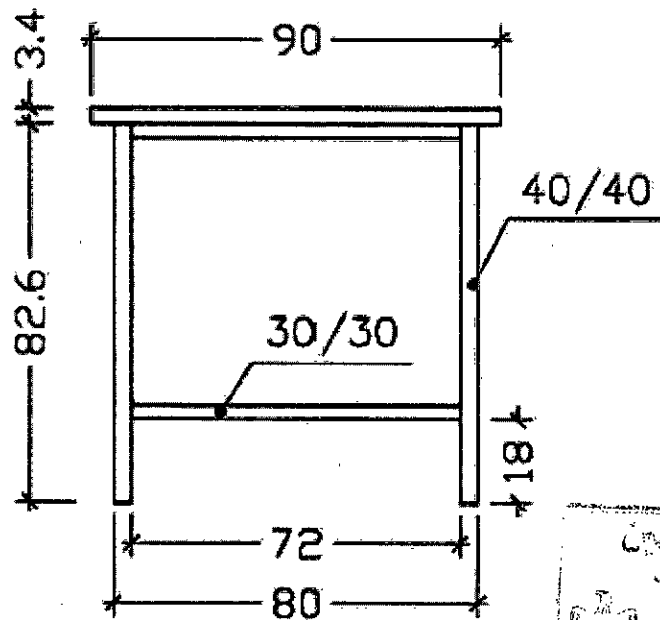
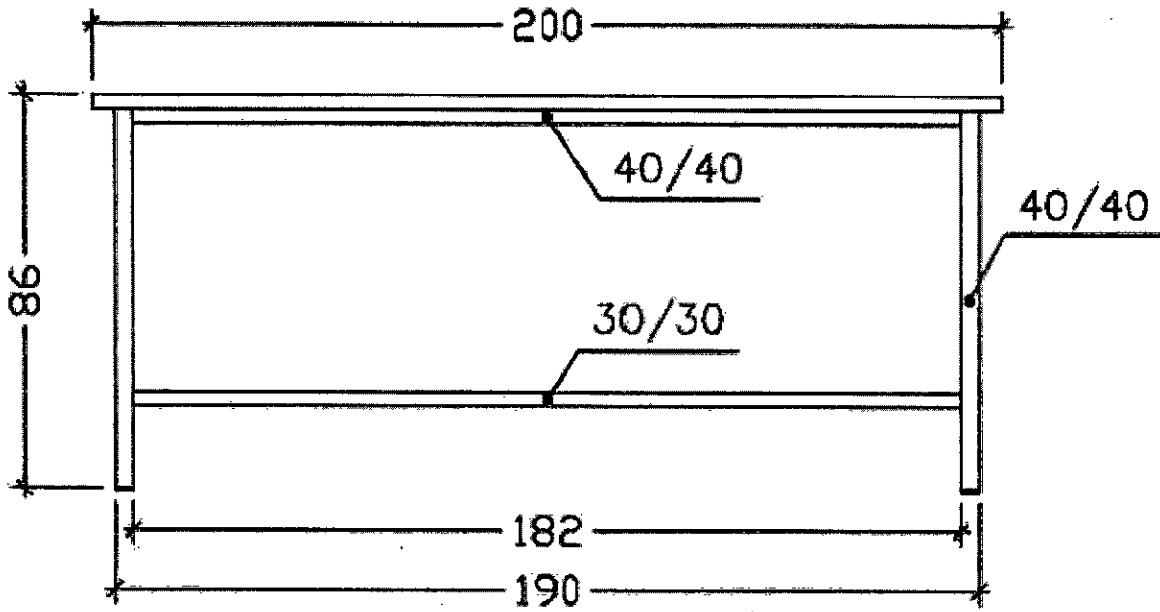

Wooden Computer Table

A: General,

105x45x72 H

B: Technical specifications.

1. Table shall be made as shown on attached figure.
2. Shall be made of plywood (sandwich) best quality, with a thickness of (17 mm).
3. Top board of the table (face) shall be made of (MDF) of best quality with thickness of 17 mm. with rounded as a ½ circle for all edges, the four edges shall be painted with at least 3 layers of base and transparent lacquer paint, as shown on attached figure.
4. Wooden board (for keyboard) shall slide on steel rails 1.25 mm thickness with wheels to ensure smooth movement, Natural Wooden (U) shape piece shall be fixed on front side of this board.
5. The edges of top board (face) should be rounded as quarter circle and painted with at least 3 layers of base and transparent lacquer paint.
6. -All parts of the table shall be covered with a layer of melamine. Colour Beech wood.
7. All edges should be covered by plastic belt, thickness (2mm), colour black.
8. Plastic angle heels (quantity: 4) are to be installed under the table.
9. The door of the compartment shall be fixed with chrome plated metal hinge (Yugoslavian type) of best quality, (quantity:2).
10. The compartment door shall have a cylindrical lock of best quality, to be locked firmly.
11. Metallic handle shall be fixed on this compartment door.
12. all part of the table shall be assembled by using metal angles and galvanized metal screws, special for wooden furniture.

C: Dimensions:

Height: 72 cm.
Width: 105 cm.
Depth: 45 cm.

D. Marking of goods:

The supplier shall put his commercial mark on all supplied pieces of goods by stamp or by fixing a sticker properly –approved by the Ministry- on the bottom face of the goods, this mark shall contain the name of the factory, tender No. and the financial resource, in a clear and permanent manner and approved by Ministry.

E. Packing:

The supplied goods shall be backed by using special plastic sheets to prevent scratching of paintings and surfaces of goods

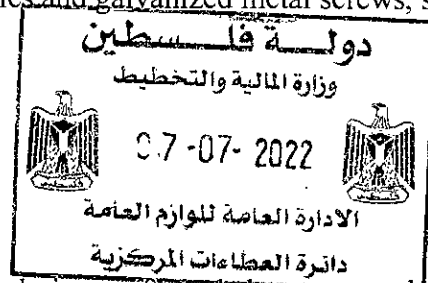

Wooden computer table:

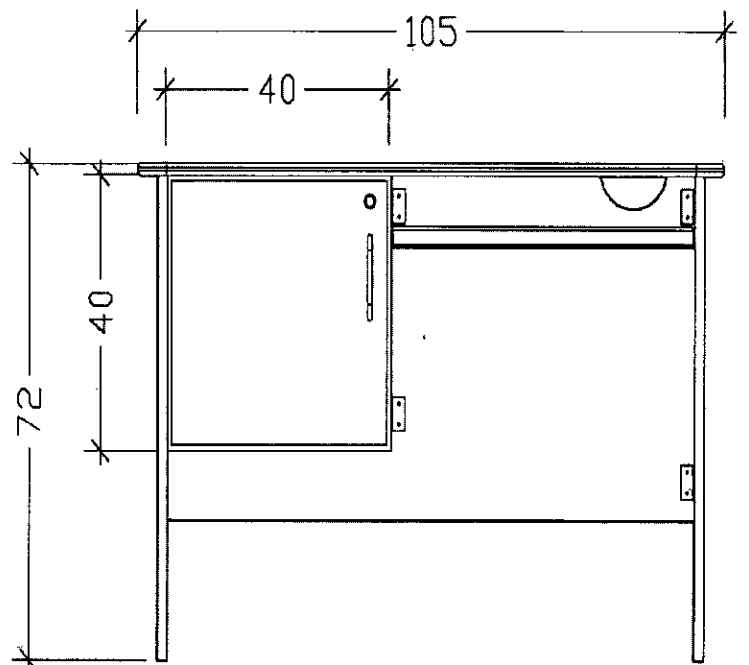
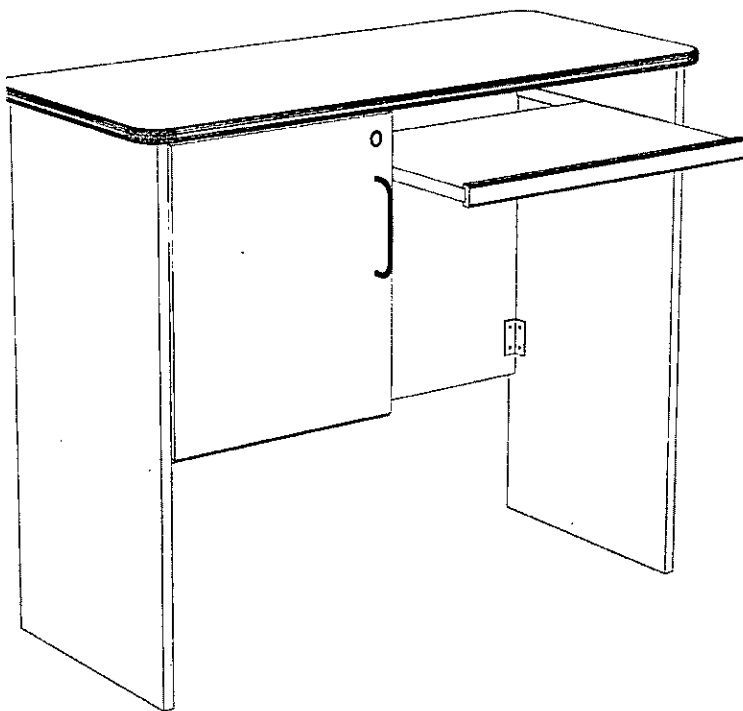
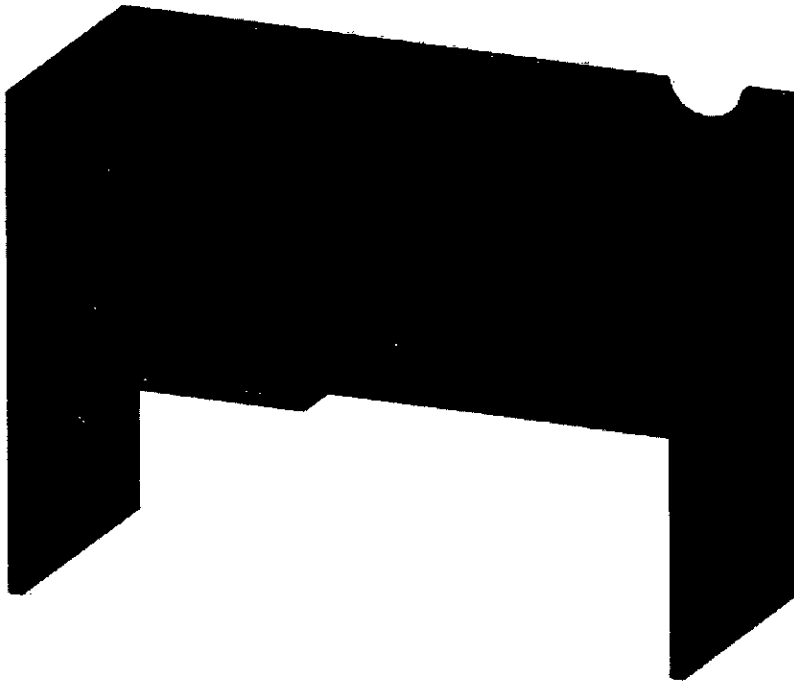

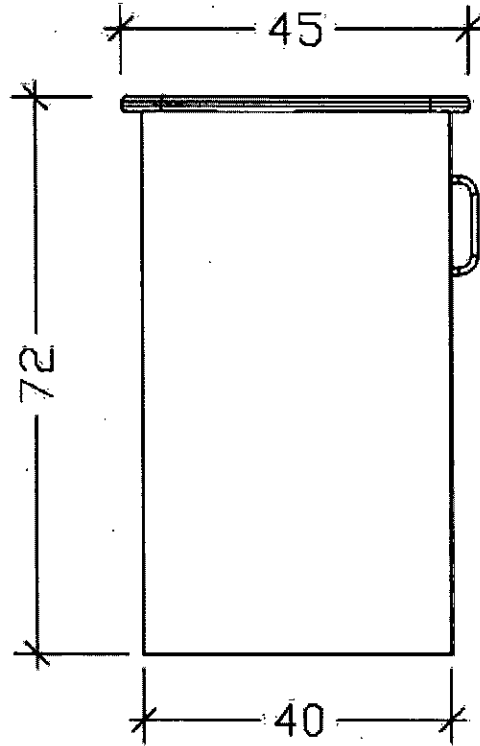

Technology lab.bench



A. General

H=85 cm

B. Technical Specifications

1. Metal framework

The metal framework shall be made from square steel profile tubes 40 x 40 mm and 30 x 30 mm and 2 mm thick.

The bottom edge of the metal frame shall be covered with black plastic heels.

All ends of the metal squares must be closed with black plastic covers.

All metal pieces are to be welded together properly, strongly and in conformity with regulations.

CO2 welding shall be used.

Plastic heels are to be installed under the legs to elevate the iron parts from the ground.

2. Table board

The table board shall be made of plywood “sandwich” board, best quality.

Thickness of plywood is 34 mm. Dimensions: 200X115 cm

It shall be covered with stretched laminated plastic sheet (Formica MATT) 0.8 mm thick. Colorgray (3130).

Beech wood shall be used in belting the edges of the table board 15 mm thick and 34 mm wide.

The beech belt shall be painted with three coats of lacquer paint in addition to prime coat and to be fixed by using adhesive materials with no nailing. Fixing of the beech belt shall be done after the lamination with the plastic sheets.

A box made of polywood (sandwich) best quality (17mm) thick shall be fixed on the board of the table as shown figure The box shall be covered with stretched laminated plastic sheet (Formica MATT) 0.8 mm thick. Colorgray (3130).

The table board shall be fixed on the metal framework using metal screws (5cm). Number of screws: 20.

3. Painting

- All metal shall be painted after applying anticorrosive treatment with at least three stages and cleaned from oil, grease, dust, and other dirt using special thermal control painting for metal furniture to form a layer of base painting of (iron phosphate) (0.4 – 0.8) gm/m².
 - Automatic spray painting shall be applied to be followed by a drying process in a thermal furnace with suitable temperature and time for the process.
 - Thickness of painting (60 – 80) micron.
 - (A box polyester powder) paint should be used, colour: blue No. 5007
- Painting of iron, assembly, delivery and storage must be carried out away from climatic influence i.e. sun, dust etc.

4. Marking of goods:

The supplier shall put his commercial mark on all supplied pieces of goods by stamp or by fixing a sticker properly –approved by the Ministry- on the bottom face of the goods, this mark shall contain the name of the factory, tender No. and the financial resource, in a clear and permanent manner and approved by Ministry.

5. Packing:

The supplied goods shall be backed by using special plastic sheets (with air babbles) to prevent scratching of paintings and surfaces of goods.

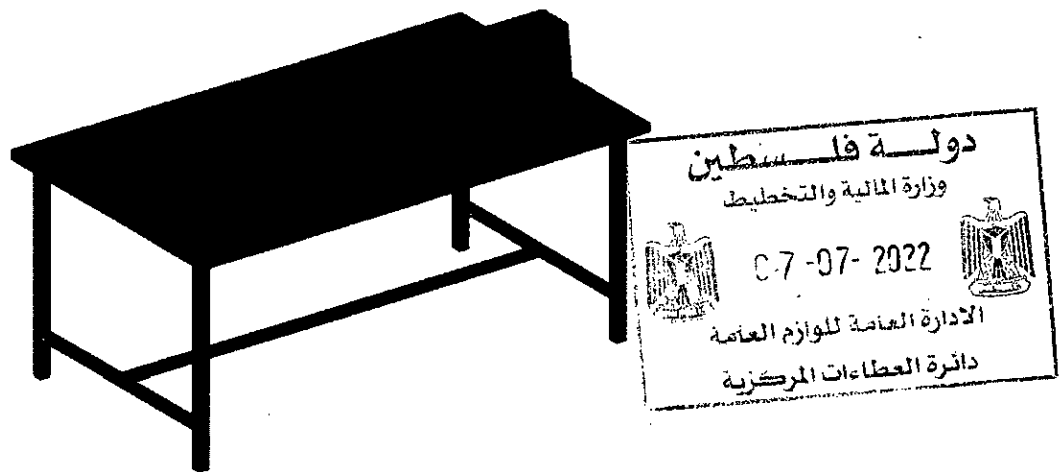

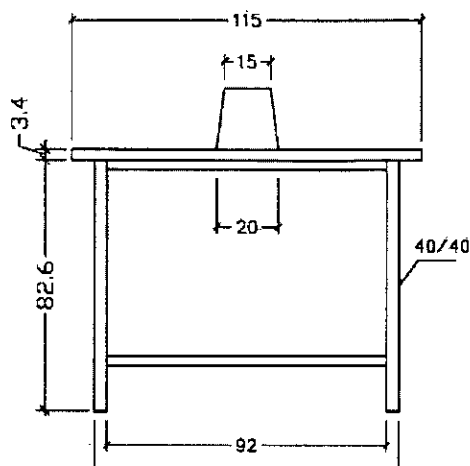
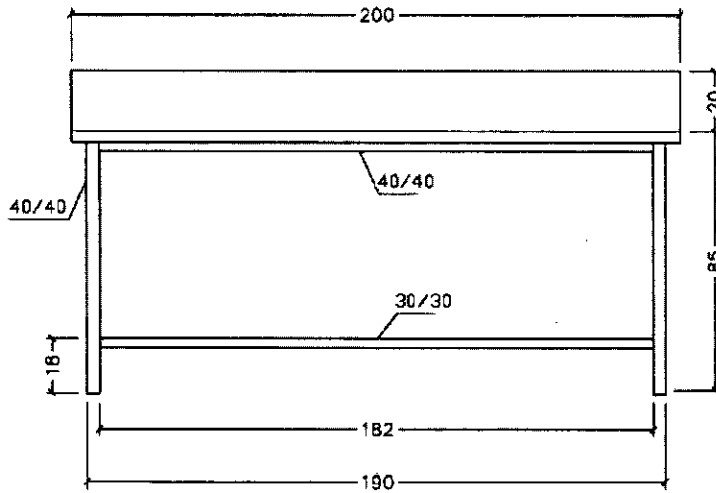
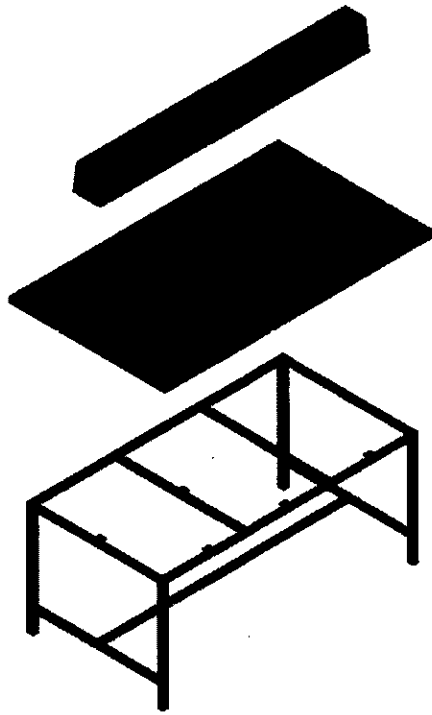

Student Drawing Table

Technical Specifications

(As shown by attached figure)

1. Metal framework

- The metal frame shall be made from hollow metal profile tubes.
- Dimensions: 20 x 20 mm and 40 x 20 mm, thickness: 1.25 mm.
- All metal pieces shall be welded together properly, strongly and in conformity with regulations.
- CO2 welding shall be used.
- Eight angles (20/20) mm. (5cm length) shall be fixed on top of framework to fix the table board
- All ends of the metal squares must be closed with black plastic covers.
- Plastic heels are to be installed under the legs to elevate the iron parts from the ground and must be fixed with metal screws.

2. Table board

- The table board shall be made of precut plywood (SANDWICH), best quality.
- Thickness of table board shall be 17 mm, dimensions: 90 x 70 cm. It shall be covered with colored plastic FORMICA matte on both sides.
- Top Formica thickness: 0.8mm. Color: grey (3130)
- Beech wood shall be used in belting the edges of the table board 15 mm thick.
- The beech belt shall be fixed by using adhesives of best quality and after fixing of Formica to the board.
- The beech belt shall be painted with three coats and prime coats.
- The edges of table board should be rounded ¼ circle, for safety.
- The board shall be provided by hinges and special metal piece for step movement (sample is available at MOE)
- The table board shall be fixed on the metal framework using galvanized metal screws, (18)-mm.
- Number of screws: 16. It should be fixed from the bottom.

3. Painting

- All metal shall be painted after applying anticorrosive treatment with at least three stages and cleaned from oil, grease, dust, and other dirt using special thermal control painting for metal furniture to form a layer of base painting of (iron phosphate) (0.4 – 0.8) gm/m².
- Automatic spray painting shall be applied to be followed by a drying process in a thermal furnace with suitable temperature and time for the process.



Section VII. General Conditions of Contract

- Thickness of painting (60 – 80) micron.
- (Aboxpolyster powder) paint should be used, color: Marengo No. 7016

Painting of iron, assembly, delivery and storage must be carried out away from climatic influence i.e. sun, dust etc.

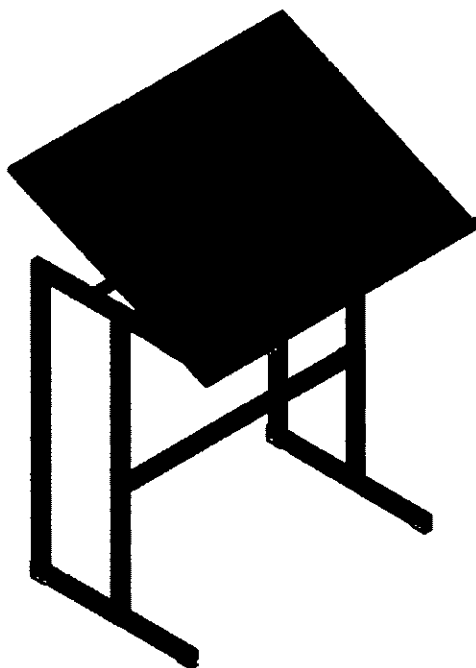
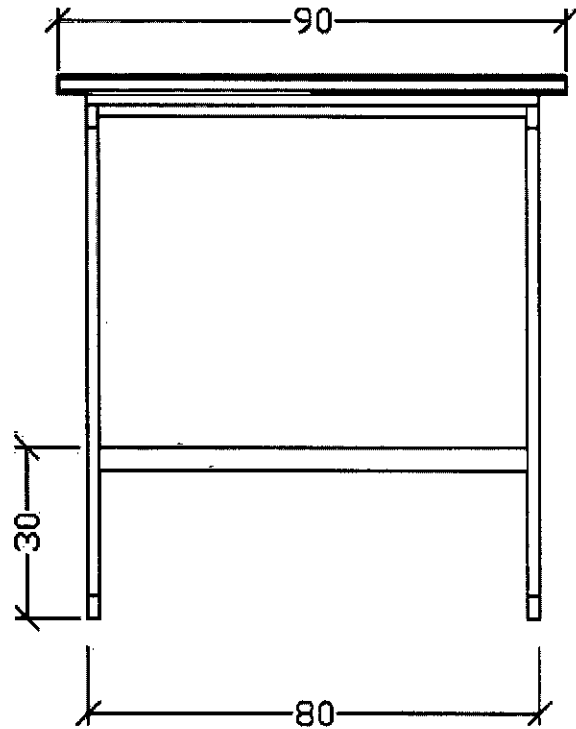
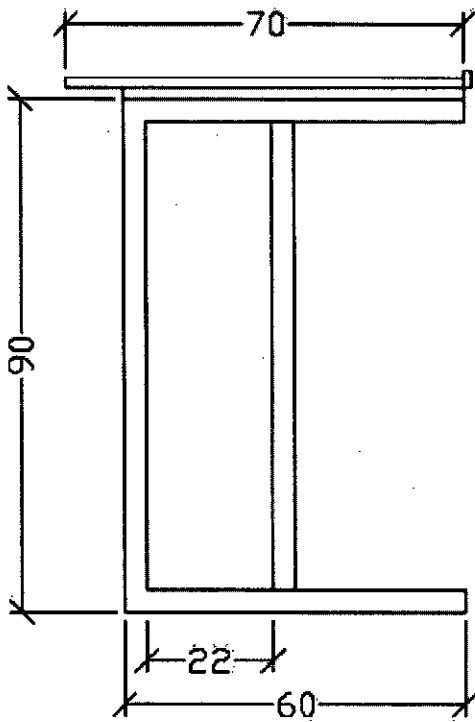

Section VIII. Special Conditions of Contract

The following Special Conditions of Contract (SCC) shall supplement and / or amend the General Conditions of Contract (GCC). Whenever there is a conflict, the provisions herein shall prevail over those in the GCC.

SCC 1.1(h)	The GSD's country is the "State of Palestine"
SCC 1.1(i)	The GSD: The General Supplies Department State of Palestine
SCC 1.1 (j)	MOE: The Ministry of Education State of Palestine
SCC 1.1 (o)	The Project Site(s)/Final Destination(s) is/are: as furnished in the Delivery Schedule
SCC 5.1	The language shall be: English
SCC 8.1	For notices , the MOE's address shall be: Attention: Mohammad Al-Quarout Director of Procurement Department Ministry of Education Old Building, Second Floor, Room 201 Ramallah, P.O. BOX () Telephone: Facsimile number: Electronic mail address: For notices ; the Supplier's address shall be:
SCC 9.1	The governing law shall be the laws of the Palestinian Authority
SCC 10.2	The rules of procedure for arbitration proceedings pursuant to GCC Clause 10.2 shall be as follows: (a) Contract with a Foreign Supplier: GCC 10.2 (a) Any dispute, controversy or claim arising out of or relating to this Contract, or breach, termination or invalidity thereof, shall be settled by arbitration in accordance with the UNCITRAL Arbitration Rules as at present in force ((see: http://www.uncitral.org/pdf/english/texts/arbitration/arb-rules-revised/arb-rules-revised-2010-e.pdf)). The place of arbitration shall be Ramallah and the Language of

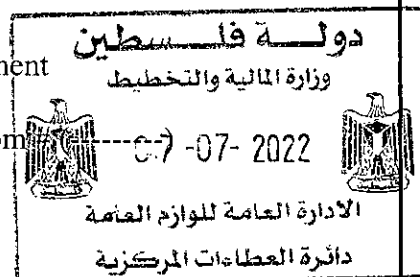

Section VIII. Special Conditions of Contract

	<p>Arbitration shall be English.</p> <p>(b) Contracts with Suppliers being registered or based in the Palestinian Territories:</p> <p>In the case of a dispute between the GSD and a Supplier who is registered or based in the Palestinian Territories, the dispute shall be referred to adjudication or arbitration in accordance with the laws of the Palestinian Authority.</p>
<p>SCC 11.1</p>	<p>Details of Shipping and other Documents to be furnished by the Supplier are:</p> <p>For Goods supplied from abroad:</p> <p>GCC 10.3 Upon shipment, the Supplier shall notify the Purchaser of the full details of the shipment, including Contract number, description of Goods, quantity, the vessel, the bill of lading (number and date), port of loading, date of shipment, port of discharge, etc. The Supplier shall mail the following documents to the Purchaser, with a copy to the Insurance Company:</p> <ul style="list-style-type: none"> (i) Copies of the Supplier's invoice showing Goods' description, quantity, unit price, and total amount; (ii) Original and (1) copy of the negotiable, clean, on-board bill of lading marked "<i>freight prepaid</i>" and (1) copy of nonnegotiable bill of lading; (iii) Copies of the packing list identifying contents of each package; (v) Manufacturer's or Supplier's warranty certificate; (vi) Certificate of origin. <p>The above documents shall be received by the Purchaser at an adequate time before arrival of the Goods at the port or place of arrival and, if not received, the Supplier will be responsible for any consequent expenses.</p> <p>For Goods from within the Purchaser's country:</p> <p>GCC 10.3 Upon delivery of the Goods to the transporter, the Supplier shall notify the Purchaser and mail the following documents to the Purchaser:</p> <ul style="list-style-type: none"> (i) Copies of the Supplier's invoice showing Goods' description, quantity, unit price, and total amount; (ii) Delivery note, railway receipt, or truck receipt; (iii) Manufacturer's or Supplier's warranty certificate; (iv) Certificate of origin. <p>The above documents shall be received by the Purchaser before arrival of the Goods and, if not received, the Supplier will be responsible for any consequent expenses.</p>

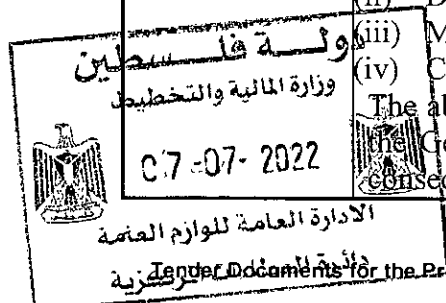

Section VIII. Special Conditions of Contract

<p>SCC 14.2</p>	<p>The prices charged for the Goods supplied and the related Services performed shall not be adjustable.</p>
<p>SCC 15.1</p>	<p>The method and conditions of payment to be made to the Supplier under this Contract shall be as follows:</p> <p>Payment for Goods and Services supplied shall be made in US Dollars, as follows:</p> <p>(i) Advance Payment: Ten (10) percent of the Contract Price shall be paid within thirty (30) days of signing of the Contract against a simple receipt and a bank guarantee for the equivalent amount and in the form furnished in <i>Section IX – Contract Forms</i>.</p> <p>(ii) On Acceptance: Eighty (80) percent of the Contract Price of each shipment shall be paid on acceptance of the Goods and upon submission of the documents specified in GCC Clause 12. Payment shall be made in accordance with GCC Clause 15.</p> <p>(iii) On Completion: The remaining ten (10) percent of the Contract Price shall be paid to the Supplier upon the completion of all his obligations under the Contract and the submission of a Defects Liability Security in the value of (10%) of the Contract Price valid for at least (delivery period + 60 days) days from the date of acceptance of the last shipment. The Defect Liability Security shall be in a form acceptable by the GSD.</p> <p>Any single payment shall not be less than US\$ 100,000 in value unless the contract Price is less than this value. If the case is so then the supplier shall submit one payment only.</p>
<p>SCC 15.5</p>	<p>The payment-delay period after which the GSD shall pay interest to the supplier shall be (60) days.</p> <p>The interest rate that shall be applied is 0 %</p>
<p>SCC 17.1</p>	<p>A Performance Security shall be required.</p> <p>The amount of the Performance Security shall be 10% of the Contract Price</p> <p>The period of Performance Security Calculated (delivery period + 60 days)</p> <p>Maintenance Guarantee for 5% of the Contract value and valid for 1 year from the provisional acceptance date.</p>

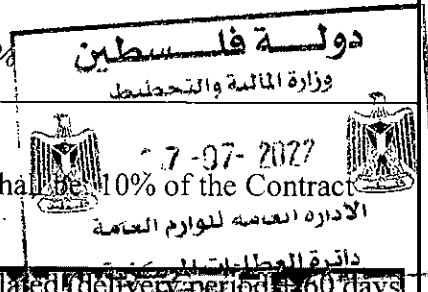

Section VIII. Special Conditions of Contract

<p>SCC 17.3</p>	<p>The Performance Security shall be in the form of a Bank Guarantee</p> <p>The Performance security shall be denominated in the currencies of the Contract.</p> <p>The Performance Security shall be in the form attached in Section IX.</p> <p>The Performance Security shall be valid for the period of executing the Contract.</p>
<p>SCC 22.2</p>	<p>The packing, marking and documentation within and outside the packages shall be (for Imported Goods):</p> <ul style="list-style-type: none"> - All furniture parts shall be packed in accordance with good commercial practice, protected from damage during handling and shipping, suitable for tailgate unloading by forklift. - The Supplier shall clearly identify each carton with large stenciling (or other marking visible from a distance) showing Item, Colour, Part Number and School identification number. - Any parts found to be damaged in shipping shall be replaced immediately and at no expense to the GSD.
<p>SCC 23.1</p>	<p>The insurances required from the Supplier shall be an Insurance of Goods whether in transit or stored or delivered and shall not be less than 110% of the Contract Price and shall be on “All Risks” basis, including War Risks and Strikes. (NOT APPLICABLE)</p>
<p>SCC 24.1</p>	<p>Responsibility for transportations shall be as follows: “The Supplier is required under the Contract to transport the Goods to the final destination within the State of Palestine (as furnished in the Delivery Schedule). Transport to such places of destination in the Palestinian Territories, as shall be specified in the Contract including storage, shall be arranged by the Supplier, and related costs shall be included in the Contract Price. The Contractor shall bear all risks relating to the goods until provisional acceptance at destination. The supplies shall be packaged so as to prevent their damage or deterioration in transit to their destination”.</p>



Section VIII. Special Conditions of Contract

<p>SCC 25.5</p>	<p>The inspections and tests shall be:</p> <p>(i) All tests necessary to confirm the compliance of the goods and their components with the Technical Specifications.</p> <p>(ii) Tests requested by the GSD upon inspection for acceptance of delivery. These tests might be conducted by the Palestinian Standards Institute (PSI).</p> <p>(iii) Samples shall be provided by the Supplier before the contract award for inspection by the GSD. The delivery of the samples including cost of manufacturing, transportation back and forth to the GSD, duties, taxes and other levies as well as the cost of testing shall be at the expenses of the Supplier.</p> <p>(iv) The costs of testing shall be paid by the Supplier and are considered to be included in the Supplier's prices.</p>
<p>SCC 25.6</p>	<p>The Inspections and tests shall be conducted at: All places mentioned in the GCC (25.6) and at GSD, Ramallah or any other place identified by the GSD.</p> <p>All Expenses related to inspections and tests shall be included in the prices of the Supplier.</p> <p>Inspections and tests might be conducted during the production, manufacturing, assembling or preparation processes</p> <p>If inspections are to be conducted at the manufacturer's premises and country then the related costs will be borne by the GSD. The Supplier shall facilitate such inspections.</p>
<p>SCC 26.1</p>	<p>The liquidated damage shall be: half (0.5) percent of the contract price per week.</p>
<p>SCC 26.1</p>	<p>The maximum amount of liquidated damages shall be: ten (10) percent of the contract price.</p>
<p>SCC 27.3</p>	<p>The period of validity of the Warranty shall be: (365) days from the last acceptance date.</p> <p>For purposes of the Warranty, the place(s) of final destination(s) shall be: As indicated in the Delivery Schedule.</p> <p>The Warranty shall be in the form of a Judicial Guarantee by the name of the Supplier or by the name of the Local Agent in case of International Supplier for the amount of 115% of the Contract Price.</p>
<p>SCC 27.5</p>	<p>The period for repair or replacement shall be: (30) days.</p>

دولة فلسطين
 وزارة المالية والتخطيط
 07-07-2022
 وزارة العامة للوزم العامة
 دائرة العطاءات المركزية

Section IX. Contract Forms

Table of Forms

1. Contract Agreement	119
2. Performance Security Form.....	121
3. Standard Form of an Advance Payment Bond	122

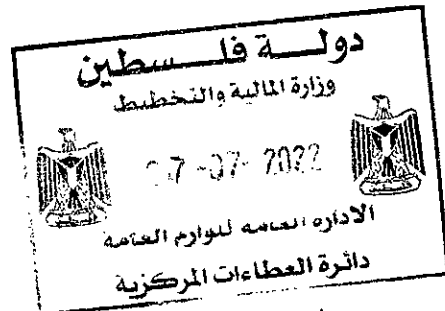

1. Contract Agreement

[The successful Bidder shall fill in this form in accordance with the instructions indicated]

THIS CONTRACT AGREEMENT is made

the *[insert: number]* day of *[insert: month]*, *[insert: year]*.

BETWEEN

- (1) *[insert complete name of MOE]*, a *[insert description of type of legal entity, for example, an agency of the Ministry of of the Government of {insert name of Country of PD}, or corporation incorporated under the laws of {insert name of Country of PD}]* and having its principal place of business at *[insert address of PD]* (hereinafter called "the PD"), and
- (2) *[insert name of Supplier]*, a corporation incorporated under the laws of *[insert: country of Supplier]* and having its principal place of business at *[insert: address of Supplier]* (hereinafter called "the Supplier").

WHEREAS the PD invited bids for certain Goods and ancillary services, viz., *[insert brief description of Goods and Services]* and has accepted a Bid by the Supplier for the supply of those Goods and Services in the sum of *[insert Contract Price in words and figures, expressed in the Contract currency (ies)]* (hereinafter called "the Contract Price").

NOW THIS AGREEMENT WITNESSETH AS FOLLOWS:

1. In this Agreement words and expressions shall have the same meanings as are respectively assigned to them in the Conditions of Contract referred to.
2. The following documents shall constitute the Contract between the PD and the Supplier, and each shall be read and construed as an integral part of the Contract:
 - (a) This Contract Agreement
 - (b) Special Conditions of Contract
 - (c) General Conditions of Contract
 - (d) Technical Requirements (including Schedule of Requirements and Technical Specifications)
 - (e) The Supplier's Bid and original Price Schedules
 - (f) The PD Notification of Award
 - (g) *[Add here any other document(s)]*

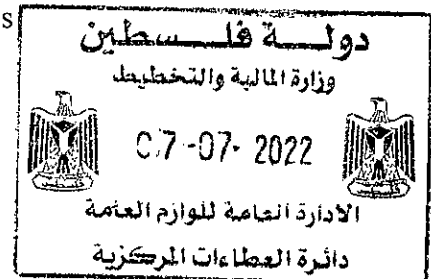

Section IX. Contract Forms

3. This Contract shall prevail over all other Contract documents. In the event of any discrepancy or inconsistency within the Contract documents, then the documents shall prevail in the order listed above.
4. In consideration of the payments to be made by the MOE to the Supplier as hereinafter mentioned, the Supplier hereby covenants with the MOE to provide the Goods and Services and to remedy defects therein in conformity in all respects with the provisions of the Contract.
5. The MOE hereby covenants to pay the Supplier in consideration of the provision of the Goods and Services and the remedying of defects therein, the Contract Price or such other sum as may become payable under the provisions of the Contract at the times and in the manner prescribed by the Contract.

IN WITNESS whereof the parties hereto have caused this Agreement to be executed in accordance with the laws of *[insert the name of the Contract governing law country]* on the day, month and year indicated above.

For and on behalf of the PD

Signed: *[insert signature]*
in the capacity of *[insert title or other appropriate designation]*
in the presence of *[insert identification of official witness]*

For and on behalf of the Supplier

Signed: *[insert signature of authorized representative(s) of the Supplier]*
in the capacity of *[insert title or other appropriate designation]*
in the presence of *[insert identification of official witness]*



2. Performance Security Form

To: Ministry of Education

Date: _____

Contract Name: *Supply and Delivery of Administrative Furniture*

Contract No.: **MOE-GSD/ JFA.8,13.312235/2022 /136**

Gentlemen and/or Ladies:

Address of guarantor bank:

.....

Address of beneficiary (contracting agency):

.....

On You concluded with ("Contractor") a contract for
 (Manufacture and supply school furniture / West Bank)
) at a price of

In accordance with the provisions of the contract, the Contractor is obliged to provide a performance bond for (10 %) ten percent of the contract price.

We, the undersigned (Guarantor), waiving all objections and defenses under the aforementioned contract, hereby irrevocably and independently guarantee to pay on your first written demand any amount up to a total of (In words:)

Against your written declaration that the Contractor has failed to perform the aforementioned contract.

In the event of any claim under this guarantee, payment shall be effected to the Palestinian Ministry of Education Account Number (219000/13) with the Bank of Palestine SWIFT Code PALSPS22.

This guarantee shall expire not later than

By this date we must have received any claims by letter, email or encoded telecommunication.

It is understood that you will return this guarantee to us on expiry or after payment of the total amount to be claimed hereunder.

This guarantee is governed by the law of the Palestinian Authority.

Place, date _____



Guarantor _____

3. Standard Form of an Advance Payment Bond

Address of guarantor bank:

.....
.....
.....

Address of Beneficiary (contracting agency):

.....
.....
.....

On you concluded with ("Contractor") a contract for (project, object of contract) at a price of

In accordance with the provisions of the contract the Contractor receives an advance payment in the amount of, which represents % of the order value.

We, the undersigned (Guarantor), waiving all objections and defences under the aforementioned contract, hereby irrevocably and independently guarantee to pay on your first written demand any amount advanced to the Contractor up to a total of (in words:) against your written declaration that the Contractor has failed to duly perform the aforementioned contract.

This guarantee shall come into force and effect as soon as the advance payment has been credited to the account of the Contractor.

In the event of any claim under this guarantee, payment shall be effected to the Palestinian Ministry of Finance's Account Number (219000/49) with The Bank of Palestine SWIFT Code PALSPS22.

This guarantee shall expire no later than

By this date we must have received any claims for payment by letter, email or encoded telecommunication.

It is understood that you will return this guarantee to us on expiry or after payment of the total amount to be claimed hereunder.

This guarantee is governed by the laws of the Palestinian Authority.

.....
Place, date

.....
Guarantor

